Operating instructions and spare parts list

OptiGun GA03-P

Automatic powder gun

CE₀₁₀₂ Ex II 2D



Translation of the original operating instructions

Documentation OptiGun GA03-P Automatic powder gun

© Copyright 2012 Gema Switzerland GmbH

All rights reserved.

This publication is protected by copyright. Unauthorized copying is prohibited by law. No part of this publication may be reproduced, photocopied, translated, stored on a retrieval system or transmitted in any form or by any means for any purpose, neither as a whole nor partially, without the express written consent of Gema Switzerland GmbH.

MagicCompact, MagicCylinder, MagicPlus, MagicControl, OptiFlex, OptiControl, OptiGun, OptiSelect, OptiStar and SuperCorona are registered trademarks of Gema Switzerland GmbH.

OptiFlow, OptiCenter, OptiMove, OptiSpeeder, OptiFeed, OptiSpray, OptiSieve, OptiAir, OptiPlus, OptiMaster, MultiTronic, EquiFlow, Precise Charge Control (PCC), Smart Inline Technology (SIT) and Digital Valve Control (DVC) are trademarks of Gema Switzerland GmbH.

All other product names are trademarks or registered trademarks of their respective holders.

Reference is made in this manual to different trademarks or registered trademarks. Such references do not mean that the manufacturers concerned approve of or are bound in any form by this manual. We have endeavored to retain the preferred spelling of the trademarks, and registered trademarks of the copyright holders.

To the best of our knowledge and belief, the information contained in this publication was correct and valid on the date of publication. Gema Switzerland GmbH makes no representations or warranties with respect to the contents or use of this publication, and reserves the right to revise this publication and make changes to its content without prior notice.

For the latest information about Gema products, visit www.gemapowdercoating.com.

For patent information, see www.gemapowdercoating.com/patents or www.gemapowdercoating.us/patents.

Printed in Switzerland

Gema Switzerland GmbH
Mövenstrasse 17
9015 St.Gallen
Switzerland

Phone: +41-71-313 83 00

Fax.: +41-71-313 83 83

E-Mail: info@gema.eu.com

Table of contents

General safety regulations	3
Safety symbols (pictograms).....	3
Proper use.....	3
Product-specific safety measures.....	4
OptiGun GA03-P automatic powder gun	4
About this manual	5
General information	5
Product description	7
Field of application	7
Utilization.....	7
Reasonably foreseeable misuse.....	7
Technical data.....	8
Electrical data	8
Dimensions	8
Processible powders.....	8
Design and function	9
Scope of delivery	9
Available accessories	9
SuperCorona ring.....	10
Principle of function.....	12
High voltage generation.....	12
Circuit.....	12
Powder flow and electrode rinsing air.....	12
Spray nozzle	13
Typical properties – Characteristics of the functions	14
Connection for SuperCorona Ring.....	14
Commissioning	15
Preparation for start-up.....	15
Basic conditions.....	15
Connect the OptiGun automatic powder gun.....	15
Initial start-up	17
Operation	18
Setting of total air	18
Setting the powder quantity	19
Setting the electrode rinsing air	19
Functional check.....	20
General information	20
Troubleshooting	20
Start-up and powder coating.....	20
Shut-down.....	21

Cleaning and maintenance	23
General information	23
Cleaning.....	23
Cleaning the Automatic gun	23
Cleaning the spray nozzle	24
Maintenance	25
Replacing parts.....	25
Dismantling the gun.....	25
General information	25
Dismantling procedure.....	26
Assembling the powder gun	31
Repairing the powder gun	31
Connecting the diffuser.....	32
Fault localization	33
General information	33
Spare parts list	35
Ordering spare parts.....	35
OptiGun GA03-P – complete.....	36
OptiGun GA03-P – gun body.....	37
OptiGun GA03-P – shaft.....	38
OptiGun GA03-P-X – complete	39
OptiGun GA03-P-X – gun body	40
OptiGun GA03-P-X – Extension tube	41
Gun cable	42
OptiGun GA03-P – SuperCorona	43
OptiGun GA03-P – angled nozzles	44
OptiGun GA03-P – accessories	45
OptiGun GA03-P flat jet nozzles – overview (wearing parts).....	45
OptiGun GA03-P round jet nozzles – overview (wearing parts).....	46
OptiGun GA03-P gun extensions	47
OptiGun GA03-P spray nozzles for extensions – overview (wearing parts).....	48

General safety regulations

This chapter sets out the fundamental safety regulations that must be followed by the user and third parties using the OptiGun GA03-P Automatic powder gun.

These safety regulations must be read and understood before the OptiGun GA03-P is put into operation.

Safety symbols (pictograms)

The following warnings with their meanings can be found in the Gema Switzerland operating instructions. The general safety precautions must also be followed as well as the regulations in the operating instructions.

**DANGER!**

Danger due to electrically live or moving parts. Possible consequences: death or serious injury

**WARNING!**

Improper use of the equipment could damage the machine or cause it to malfunction. Possible consequences: minor injuries or damage to equipment

**INFORMATION!**

Useful tips and other information

Proper use

1. The OptiGun GA03-P Automatic powder gun is built to the latest specification and conforms to the recognized technical safety regulations and is designed for the normal application of powder coating.
2. Any other use is considered non-compliant. The manufacturer shall not be liable for damage resulting from such use; the user bears sole responsibility for such actions. Gema Switzerland GmbH must be consulted prior to any use of the OptiGun GA03-P automatic powder gun OptiGun GA03-P for any purposes or substances other than those indicated in our guidelines.

3. Observance of the operating, service and maintenance instructions specified by the manufacturer is also part of conformity of use. The OptiGun GA03-P should only be used, maintained and started up by trained personnel, who are informed about and are familiar with the possible hazards involved.
4. Start-up (i.e. the execution of a particular operation) is forbidden until it has been established that the OptiGun GA03-P Automatic powder gun has been set up and wired according to the guidelines for machinery (2006/42 EG). EN 60204-1 (machine safety) must also be observed.
5. Unauthorized modifications to the OptiGun GA03-P Automatic powder gun exempt the manufacturer from any liability from resulting damage.
6. The relevant accident prevention regulations, as well as other generally recognized safety regulations, occupational health and structural regulations are to be observed.
7. Furthermore, the country-specific safety regulations also must be observed.

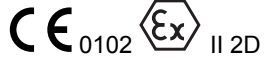
Explosion protection	Protection type	Temperature class
	IP64	T6 (zone 21) T4 (zone 22)

Product-specific safety measures

- Installation work performed by the customer must be carried out according to local regulations.
- All components must be grounded according to the local regulations before start-up.

OptiGun GA03-P automatic powder gun

The OptiGun GA03-P Automatic powder gun is a constituent part of the system and is thus integrated into the safety system of the plant.

If it is to be used in a manner outside the scope of the safety concept, then corresponding measures must be taken.



NOTE:

For further security information, see the more detailed Gema safety regulations!

About this manual

General information

This operating manual contains all the important information you require for the working with the OptiGun GA03-P Automatic powder gun. It will safely guide you through the start-up process and give you references and tips for the optimal use of your new powder coating system.

Information about the functional mode of the individual system components - booth, gun control and application pump - should be referenced in the respective enclosed documents.



DANGER:

Working without operating instructions

Working without operating instructions or with individual pages from the operating instructions may result in damage to property and personal injury if relevant safety information is not observed.

- ▶ Before working with the device, organize the required documents and read the section "Safety regulations".
 - ▶ Work should only be carried out in accordance with the instructions of the relevant documents.
 - ▶ Always work with the complete original document.
-

Product description

Field of application

The OptiGun GA03-P Automatic powder gun is built exclusively for the electrostatic coating with organic powders. Any other use is considered non-compliant. The manufacturer shall not be liable for damage resulting from such use; the user bears sole responsibility for such actions.



OptiGun GA03-P automatic powder gun

Utilization



The Automatic gun type OptiGun GA03-P is suited for the electrostatic coating of objects (in all shapes and geometries) that must be grounded.

Reasonably foreseeable misuse

- Coating of non grounded objects
- Use of enameled powder
- Incorrectly configured values for powder conveyance
- Incorrectly configured values for electrode rinsing air
- Use of moist powder

Technical data

Electrical data

OptiGun GA03-P	
Nominal input voltage	12 V
Frequency	18 kHz (average)
Nominal output voltage	100 kV
Polarity	negative (optional: positive)
Max. output current	100 μ A
Ignition protection	Type A acc. EN 50177 Ex 2 mJ T6
Temperature range	0 °C - +40 °C (+32 °F - +104 °F)
Max. surface temperature	85 °C (+185 °F)
Protection type	IP64
Approvals	 0102  II 2 D PTB 11 ATEX 5006-1

Dimensions

OptiGun GA03-P	
Weight	600 g

Processible powders

OptiGun GA03-P	
Plastic powder	yes
Metallic powder	yes
Enamel powder	no



WARNING:

The OptiGun GA03-P Automatic powder gun may only be connected to the following control units:
OptiStar CG12-CP and OptiStar CG11-P (with Trigger adapter only)!

Design and function

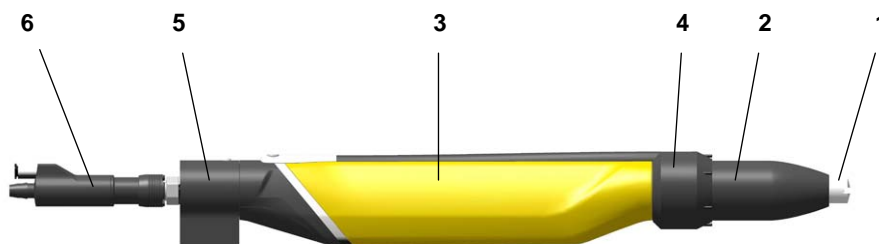

OptiGun GA03-P automatic powder gun

- | | | | |
|---|---|---|-------------|
| 1 | Spray nozzle | 5 | Gun fixture |
| 2 | Threaded sleeve | 6 | Diffuser |
| 3 | Shaft with removable high voltage cascade | | |
| 4 | SuperCorona ring | | |

Scope of delivery

- OptiGun GA03-P Automatic powder gun with gun cable (20 m)*, negative polarity
- Electrode rinsing air hose (20 m)*
- Flat jet nozzle NF27, complete (incl. electrode holder)
- Cable tie with Velcro closure
- Gun cleaning brush
- Spare parts kit
- Operating manual

* standard

Available accessories

- SuperCorona ring
- Flat jet nozzle (for specific applications)
- Round jet nozzles
- Gun extension 150 and 300 mm
- Angled nozzles 45°, 60° and 90°
- Gun cable extensions

For more information, see spare parts list!

SuperCorona ring

Field of application

The SuperCorona is an optional extension for the OptiGun GA03-P Automatic powder gun, allowing for a better surface quality when coating with the powder coating equipment.

When coating wheel rims, drawers, radiators, lamps etc. the surface quality is exceptional, also in places with higher coating layer requirements. By coating with several powder types, an "orange peel" finish can be completely avoided. By coating with structure powder, the "picture frame effect" is hardly visible.

The performance of the OptiGun with SuperCorona is convincing due to its very good charging and very high deposition rate as well as an improved penetration into Faraday cages. The distance between nozzle and workpiece can be reduced to 100 mm without influencing the surface finish.



SuperCorona – retrofit

Due to its modular structure, the OptiGun Automatic powder gun can be extended quickly and easily with the lightweight SuperCorona (approx. 75 g). The OptiGun remains repair-friendly and easy to maintain even after reconfiguration.

SuperCorona assembly

Before fitting the SuperCorona ring, make sure that the connection and the plug-in connector are free from grease and powder, otherwise the electric contact cannot be guaranteed.

1.



2.

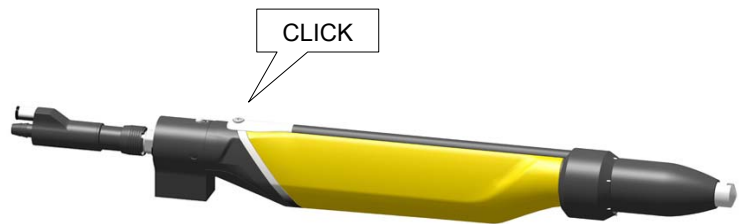

Principle of function

High voltage generation

The control unit supplies a high-frequency low voltage signal of approx. 12 V. This voltage is fed through the gun cable (11) and the gun plug to the high voltage cascade (4) in the gun body.

In the high voltage cascade (4), the low voltage is high-transformed in a first step (c). This primary high voltage is subsequently rectified and multiplied in the high voltage cascade in a second step (d), until the required high voltage is obtained at the end (approx. 100 kV). The high voltage is now fed to the electrode (e) within the spray nozzle.

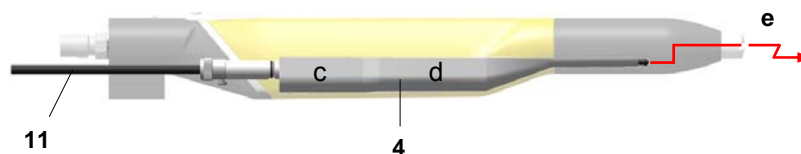

High voltage generation

Circuit

The OptiGun Automatic powder gun is switched on and off by the gun control module.

The control unit allows also the adjustment of low voltage, powder flow and electrode rinsing air to the gun.

Powder flow and electrode rinsing air

The electrode rinsing air is used by vented spray nozzles and is connected with its designated connection on the rear side of the gun control unit (see the operating manual of the gun control unit).

The functions of the spray nozzles are described in the following sections.

Spray nozzle

Flat jet nozzle with vented central electrode

The vented flat jet nozzle serves for the spraying and the charging of the powder. The powder is charged by the central electrode. The high voltage created in the gun cascade is guided through the center electrode.

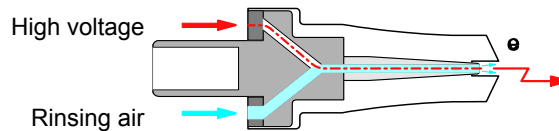

Flat jet nozzle with vented central electrode

In order to prevent powder from sintering on the electrode, compressed air is used during the spray process.

The electrode rinsing air adjustment on the gun control unit is described in the corresponding operating manual.

Round jet nozzle with vented deflector and vented central electrode

The vented deflector is used, to give the powder stream emerging from the gun, a cloud formation. The powder is charged by the central electrode. The high voltage created in the gun cascade is guided through the center electrode.

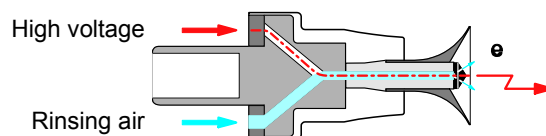

Round jet nozzle with vented deflector and vented central electrode

Since powder can accumulate on the baffle plate, it must be rinsed with compressed air.

The electrode rinsing air cleaning ability depends on the powder and its sintering ability. The electrode rinsing air adjustment on the gun control unit is described in the corresponding operating manual.

Typical properties – Characteristics of the functions

- Continuous, tightly sealed gun body with separate channels for cascade and electrode rinsing air
- Quickly removable SuperCorona ring
- Powder hose connection
- Covered hose and cable duct
- Simple conversion to a quick color change gun
- Easily dismountable by a few hand movements, therefore very easy to service
- Few wearing parts (nozzle and SuperCorona)
- Easily removable cascade because free of grease, with integrated current limiting resistors

Connection for SuperCorona Ring



- Quick and simple connection and disconnection of SuperCorona ring

Commissioning

Preparation for start-up

Basic conditions

When starting up the OptiGun GA03-P Automatic powder gun, the following general conditions impacting the coating results must be taken into consideration:

- Gun correctly connected
- Gun control unit correctly connected
- Corresponding power and compressed air supply available
- Powder preparation and powder quality

Connect the OptiGun automatic powder gun

The OptiGun GA03-P Automatic powder gun is delivered ready-to-use by the manufacturer. Just a few cables and hoses must be connected.



NOTE:

The compressed air must be free of oil and water!

The gun is connected as follows:

1. Connect electrode rinsing air hose and powder hose to gun
2. Lay out gun cable, electrode rinsing air hose and powder hose and bind using Velcro strips (included)
3. Connect the gun cable plug to the socket **2.3** on the rear side of the control unit
4. Connect electrode rinsing air hose to coupling **1.4**
5. Connect the powder hose to the Application pump
6. Connect the gun plug to the gun control unit (see therefore the operating manual of the gun control unit)
7. Connect the electrode rinsing air hose of the control unit to the gun
8. Connect the powder hose from the gun to the Application pump

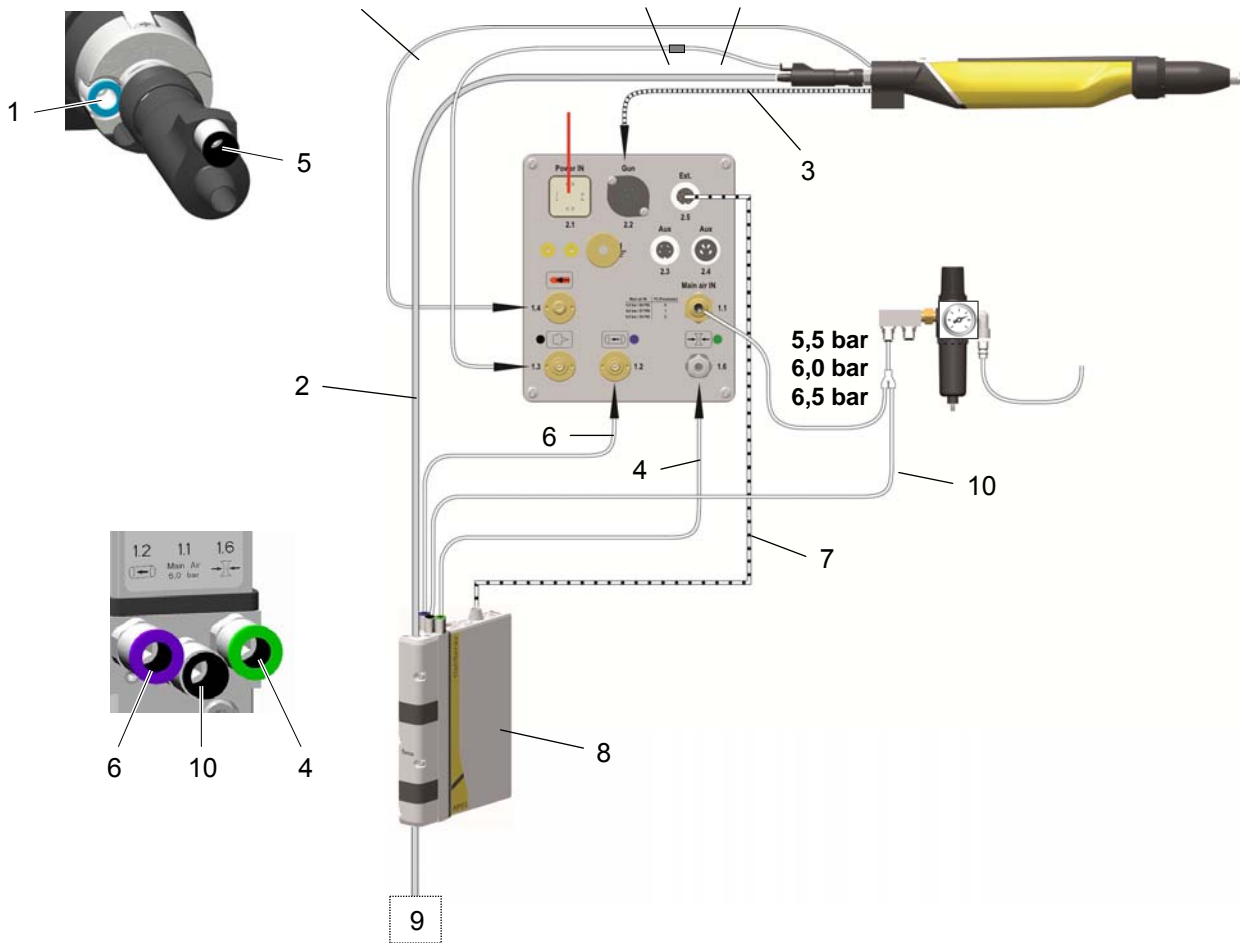

OptiGun GA03-P Automatic powder gun – Connection instructions - overview

- | | | | |
|---|----------------------------|----|----------------------|
| 1 | Electrode rinsing air hose | 6 | Transport air hose |
| 2 | Powder hose | 7 | Control signal cable |
| 3 | Gun cable | 8 | Dense phase pump |
| 4 | Pinch valve air | 9 | Powder hopper |
| 5 | Spraying air hose | 10 | Compressed air hose |
| | | 11 | Hose coupling |

Initial start-up



NOTE:

If a malfunction occurs, see the troubleshooting guide, as well as the gun control unit operating manual!

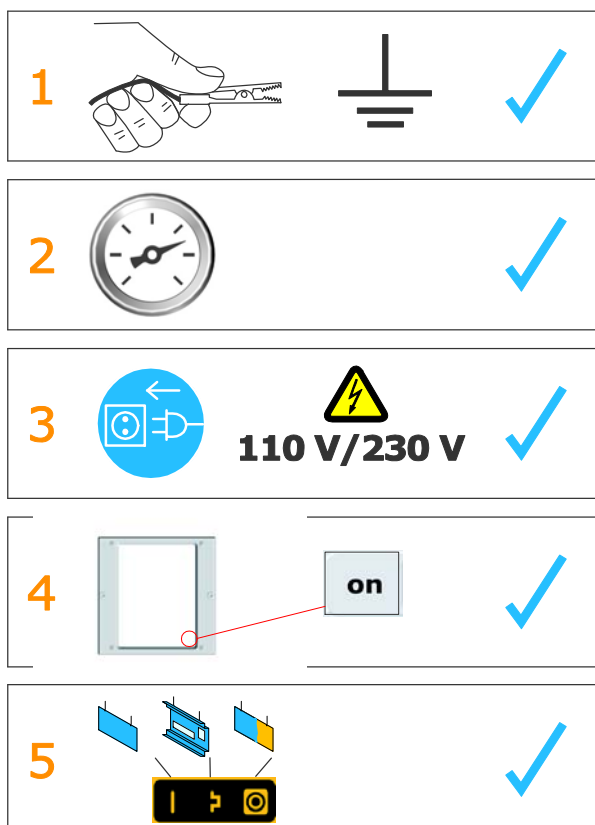

NOTE:

The further start-up procedure for the OptiGun GA03-P Automatic gun is explicitly described in the OptiStar CG12-CP/CG11-P Gun control unit operating instructions (chapter "Initial start-up" and "Daily start-up")!

Operation



DANGER!

Touching the gun parts

During the coating process, the gun can discharge along the body of the coater if touching it.

► Do not touch any parts of the gun!

Setting of total air



correct powder cloud



too little total air



NOTE:

A total air volume of 4 Nm³/h and a 50% powder share are recommended as the base values.

The total air volume is depending on the powder hose length, the number of hose curvatures, the hose diameter, the transport air pressure and the spraying air. The operation mode of the Application pump and the effect of the spraying air are described in the corresponding Application pump operating instructions.



NOTE:

The adjusted value of the total air volume can be left as it is, as long as the same diameter powder hose is used. If the hose diameter changes, the total air volume must be reset!

Setting the powder quantity

The powder output volume is selected in reference to the desired layer thickness. The selection is done on the control unit. For the beginning, the standard adjustment of 60% is recommended. The total air volume is thereby kept constant automatically.



NOTE:

The powder output depends on the powder type and the adjusted total air volume (see therefore the control unit operating manual)



much powder



little powder



NOTE:

To achieve maximum efficiency, we recommend avoided an overly high powder volume where possible!

Setting the electrode rinsing air

1. Select the correct electrode rinsing

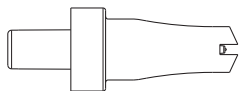

approx.
0.1 Nm³/h

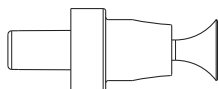

approx.
0.5 Nm³/h

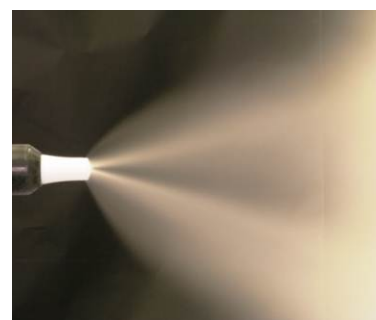

too much electrode rinsing air

2. Adjust the powder cloud with a test object

If flat jet nozzles are used:

3. Unscrew the threaded sleeve approx. 45°, so that the flat jet nozzle (or its extension) can be moved slightly
4. Turn the flat jet nozzle to desired axis direction
5. Tighten the threaded sleeve firmly again



WARNING:**Threaded sleeve not tightened well**

If the spray nozzle is just fitted loosely, there is danger of a flash-over of the gun high voltage, which can damage the gun!

- Always tighten the threaded sleeve well.
-

If round jet nozzles with air rinsed deflectors are used:

6. Replace the deflector (Ø 16, 24 and 32 mm are supplied with the gun)

Functional check

General information

1. The installed gun must be pointed towards a grounded work piece in the coating booth All connections must be attached!
2. Turn on the gun control unit (see also the control unit operating instructions) - the gun starts spraying
3. Adjust the desired coating parameters (powder volume, total air and high voltage) on the gun control unit (see also the control unit operating instructions)
4. Adjust the electrode rinsing air on the control unit dependent upon the nozzle used

If all tests have been completed positively, the gun is ready for operation. If malfunctions take place, the cause of the fault can be located by the corresponding troubleshooting guide.

Troubleshooting

If a malfunction occurs, see section "Troubleshooting". Please consider also the control unit operating instructions.

Start-up and powder coating



WARNING:

Make sure first, that all electrically conductive parts within 5 m of the coating booth are grounded!

1. Check the powder fluidization
2. The installed gun must be pointed towards a grounded work piece in the coating booth
3. Switch on the gun control unit
4. Adjust the coating parameters or select one of the programs. Check by observing the LED displays
5. The workpieces can be coated now

Shut-down

1. Switch off the powder gun control unit. The adjustments for high voltage, powder output volume and electrode rinsing air remain stored.
2. If working interruptions take place, such as lunch time, night time etc. disconnect the main compressed air supply

Cleaning and maintenance

General information



NOTE:

Regular, careful cleaning and maintenance extends the service life of the OptiGun GA03-P Automatic powder gun and ensures long-lasting, uniform coating quality!

- ▶ The parts, which are to be replaced during maintenance work, are available as spare parts. These parts will be found in the corresponding spare parts list!



WARNING:

All unauthorized modifications to the OptiGun GA03-P Automatic powder gun are forbidden for safety reasons, and exempt the manufacturer from any liability from resulting damage!

Cleaning

Cleaning the Automatic gun



NOTE:

Before cleaning the powder gun, switch off the control unit. The compressed air used for cleaning must be free of oil and water!

Daily

1. Blow off the outside of the gun and wipe, clean etc.

Weekly

2. Remove powder hose
3. Remove the spray nozzle from the gun and clean it with compressed air
4. Blow through the gun with compressed air, beginning from the connection in flow direction
5. Clean the integrated gun tube with the brush supplied, if necessary

6. Blow through the gun with compressed air again
7. Clean the powder hose
8. Reassemble the gun and connect it



WARNING:

The following solvents may not be used to clean the OptiGun GA03-P Automatic powder gun:
 Ethylene chloride, acetone, ethyl acetate, methyl ethyl ketone, methylene chloride, premium gasoline, turpentine, tetrachloromethane, toluene, trichloroethylene, xylene!



NOTE:

Only cleaning agents with a flash point of a least 5 Kelvin above the ambient temperature, or cleaning places with technical ventilation are allowed!

Cleaning the spray nozzle

Daily or after each shift

- Clean the inside and outside of the spray nozzle with compressed air.
Never immerse the parts in solvents!
- Check the seating of the spray nozzles.



WARNING:

Threaded sleeve not tightened well

If the spray nozzle is just fitted loosely, there is danger of a flash-over of the gun high voltage, which can damage the gun!

- ▶ Always tighten the threaded sleeve well.

Weekly

- Remove the spray nozzle and clean on the inside with compressed air. If sinterings should have formed, then they have to be removed!

Monthly

- Check spray nozzle for wear

The flat jet nozzle is to be replaced, if:

- the spray pattern is no longer a regular oval
- deeper grooves are in the nozzle slot, or even the wall thickness is no longer recognizable
- the wedge of the electrode holder is worn

Nozzles with deflectors:

- if the wedge of the electrode holder is worn down, then the electrode holder is to be replaced

Maintenance

The OptiGun GA03-P is designed to require only a minimum amount of maintenance.

1. Clean gun with dry cloth, see chapter "Maintenance"
2. Check connection points to powder house.
3. Replace the powder hoses, if necessary.

Replacing parts

Except for the replacement of possible defective parts, there are very few repairs to be made.



NOTE:

The replacement of the cascade and the repair of the powder gun cable connection is only permitted by an authorized Gema Service center!

► Contact your Gema representative for details!

Dismantling the gun

General information



WARNING:

The gun should only be dismantled, if this is required because of a defect or pollution!

It is only to be dismantled so far, as the desired part is accessible!



WARNING:

Before dismantling the OptiGun GA03-P automatic powder gun, the control unit must be switched off and the gun plug disconnected!

Dismantling procedure



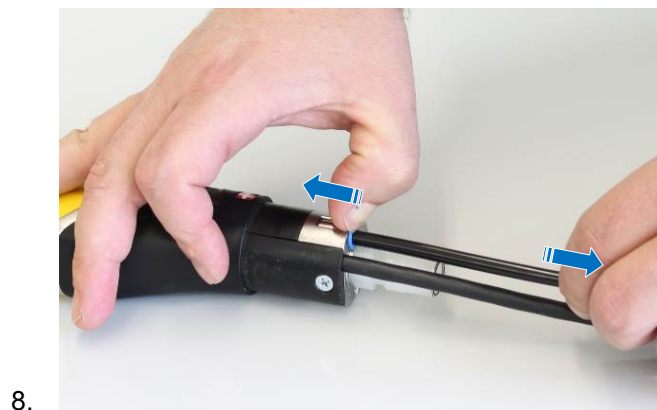





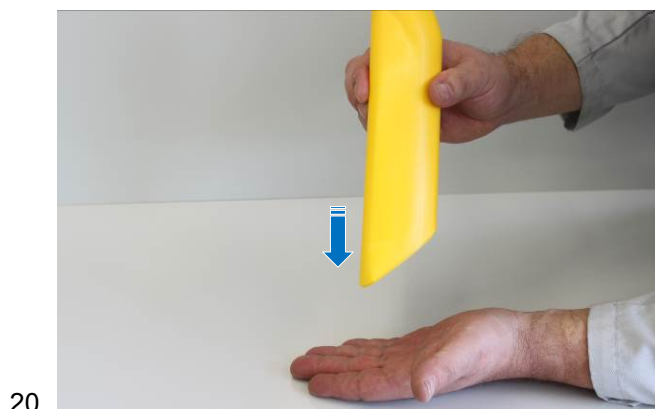

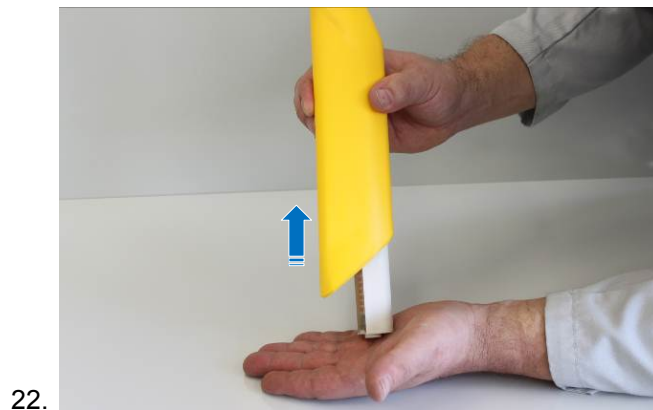

Assembling the powder gun

The assembling of the automatic gun is to be carried out in the reverse order to that shown above.

Repairing the powder gun

Apart from the replacement of possibly defective parts, hardly any repairs have to be made. The cascade can be replaced trouble-free. The repair of the gun cable connection, however, may only be made by an authorized Gema Service center.

Contact your Gema representative for details!

Connecting the diffuser

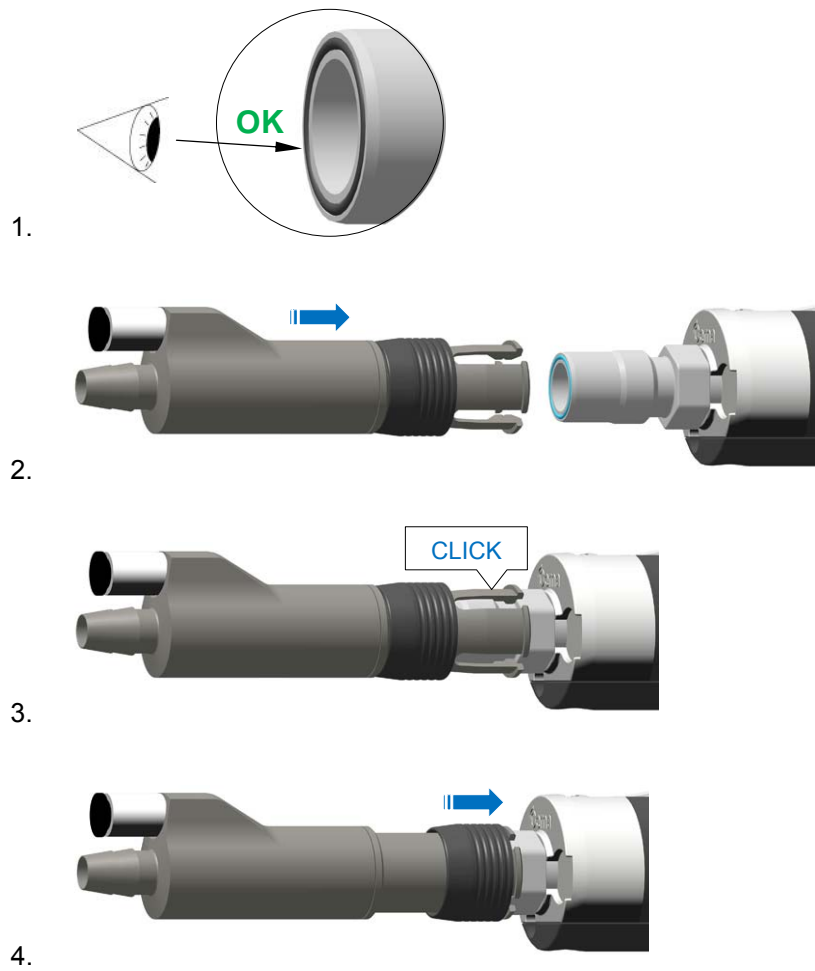

Connecting the diffuser

Fault localization

General information

Fault	Causes	Corrective action
H11 (Help code on control unit)	Gun not connected	Connect the gun
	Gun plug or gun cable defective	Contact local Gema representative
	Remote control on powder gun defective	Contact local Gema representative
The powder gun does not spray powder, although the powder gun control unit is switched on	Compressed air not present	Connect the equipment to the compressed air
	Application pump, powder hose or powder gun are clogged	Clean or replace the corresponding part
	Filter elements in the Application pump worn	Replace
	Filter elements in the Application pump clogged	Clean/replace
	Pressure valve in the control unit defective	Replace
	Solenoid valve in the control unit defective	Replace
	Electronic board in the control unit defective	Contact local Gema representative
	No transport air: - Throttle motor defective - Solenoid valve defective	Contact local Gema representative
	Powder gun sprays powder, but the powder does not adhere to workpiece	High voltage and current deactivated or too low
Gun cable (gun plug or gun connection) defective		Test the gun cable on another control unit
High voltage cascade defective		Contact local Gema representative
Electronic board in the OptiTronic defective		Send in for repair

Fault	Causes	Corrective action
Powder gun sprays powder, high voltage is available, powder does not adhere to workpiece	The objects are not properly grounded	Check the grounding
Gun achieving only poor spray profile	Total air incorrectly configured	Increase the powder quantity and/or total air volume on the control unit
	Air lines to the Application pump or to the gun bend or damaged	Check air lines
	Fluidizing tube in the gun clogged	Replace
	Filter elements in the Application pump worn	Replace
	Fluidization not running	see above



NOTE:

Additional error descriptions are to be found also in the control unit operating instructions!

Spare parts list

Ordering spare parts

When ordering spare parts for powder coating equipment, please indicate the following specifications:

- Type and serial number of your powder coating equipment
- Order number, quantity and description of each spare part

Example:

- **Type** OptiGun GA03-P automatic powder gun,
Serial number 1234 5678
- **Order no.** 203 386, 1 piece, clamp - Ø 18/15 mm

When ordering cable or hose material, the required length must also be given. The spare part numbers of this bulk stock is always marked with an *.

Wearing parts are always marked with a #.

All dimensions of plastic hoses are specified with the external and internal diameter:

Example:

Ø 8/6 mm, 8 mm outside diameter (o/d) / 6 mm inside diameter (i/d)



WARNING!

Use of non-original Gema spare parts

When using the spare parts from other manufacturers the explosion protection is no longer guaranteed. If any damage is caused by this use all guarantee claims become invalid!

- Only original Gema spare parts should be used.
-

OptiGun GA03-P – complete



NOTE:

Only parts were included in the spare parts list, which the user can replace himself without problems!

- ▶ If the powder gun cable (4) is defective, it is to be completely sent in for repair!

	OptiGun GA03-P Automatic powder gun – complete, polarity negative, incl. pos. 1-9	1010 200
	OptiGun GA03-P Automatic powder gun – complete, polarity positive, incl. pos. 1-9	1010 201
1	Powder gun body OptiGun GA03-P – complete, polarity negative	1008 728
	Powder gun body OptiGun GA03-P – complete, polarity positive	1008 729
2	Threaded sleeve – see "Nozzle combinations" spare parts list	
3	Flat jet nozzle – complete, see "Nozzle combinations" spare parts list	
4	Gun cable – complete, 20 m, see also spare parts list "Gun cable"	1008 663
5	Cylinder screw – M8x50 mm	235 113
6	Washer – Ø 8.4/20x2 mm	215 880
7	Cable tie with Velcro closure (8x) (not shown)	303 070
8	Quick release connection - NW5, Ø 6 mm, for pos. 11 (not shown)	200 840
9	Cleaning brush – Ø 12 mm (not shown)	389 765
10	Powder hose – Ø 11.5/7 mm (not shown)	1005 097*
11	Electrode rinsing air hose – Ø 6/4 mm (not shown)	103 144*

* Please indicate length

Wearing part

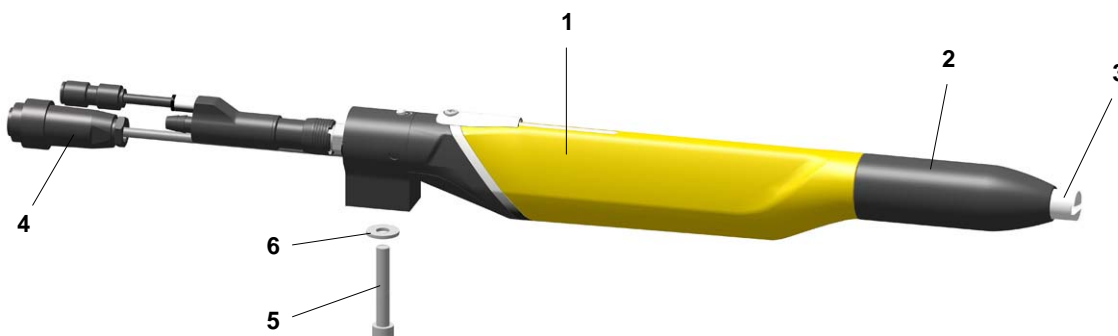

OptiGun GA03-P – complete

OptiGun GA03-P – gun body

1	OptiGun GA03-P shaft – complete, see spare parts list "Shaft"	
2	Powder tube	1008 641#
3	O-ring – Ø 12x1 mm, FPM75	1006 324#
4	Ground plate	1011 457
5	SuperCorona connection	1009 764
6	Cylinder screw – M5x6 mm	263 907
7	Gun fixture	1008 711
Diffuser – complete (incl. pos. 8-15)		1011 635
8	Clamp ring	1008 643
9	Adaptor piece	1011 633
10	O-ring – Ø 13x1.5 mm, NBR70	1009 943
11	Fluidizing tube	1005 262#
12	Connector	1011 634
13	Screw-in nipple – M7-Ø 6 mm	1008 699
14	Plastic tube – Ø 6/4 mm	103 144*
15	Plug-in connector – Ø 6-Ø 8 mm	254 894

* Please indicate length

Wearing part

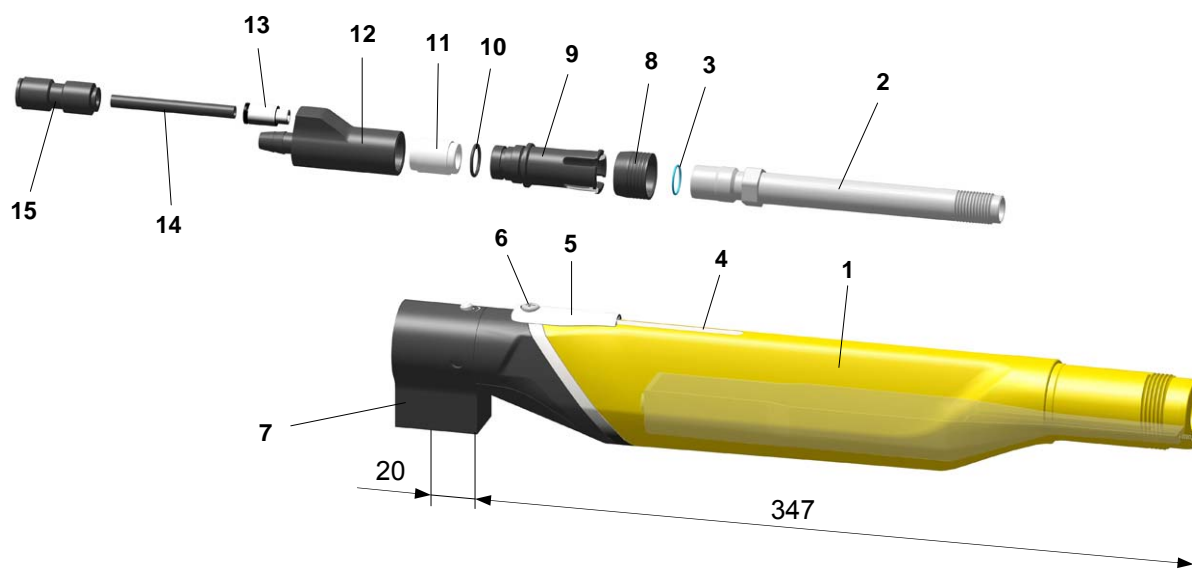

OptiGun GA03-P – gun body

OptiGun GA03-P – shaft

	Shaft OptiGun GA03-P – complete, polarity negative, incl. pos. 1-9	1008 681
	Shaft OptiGun GA03-P – complete, polarity positive, incl. pos. 1.1-9	1008 682
1	Cascade – complete, negative polarity	1007 231
1.1	Cascade – complete, positive polarity	1007 232
2	Shaft (without cascade)	1008 675
3	Sealing piece – complete (incl. pos. 3-7)	1008 690
4	Cascade space gasket	1009 646
5	Gasket	1008 686
6	Axial gasket	1008 687
8	Threaded bolt	1009 587
9	O-ring – Ø 4x1.5 mm, NBR70	264 466
10	Gun rear end – complete (incl. pos. 10-13)	1008 701
11	Lock knob	382 833
12	Screw – M3x3 mm	266 795
13	Screw-in nipple – M7-Ø 6 mm	1008 699
14	Rear end cover	1008 697
15	Countersunk head screw – M4x6 mm	214 639

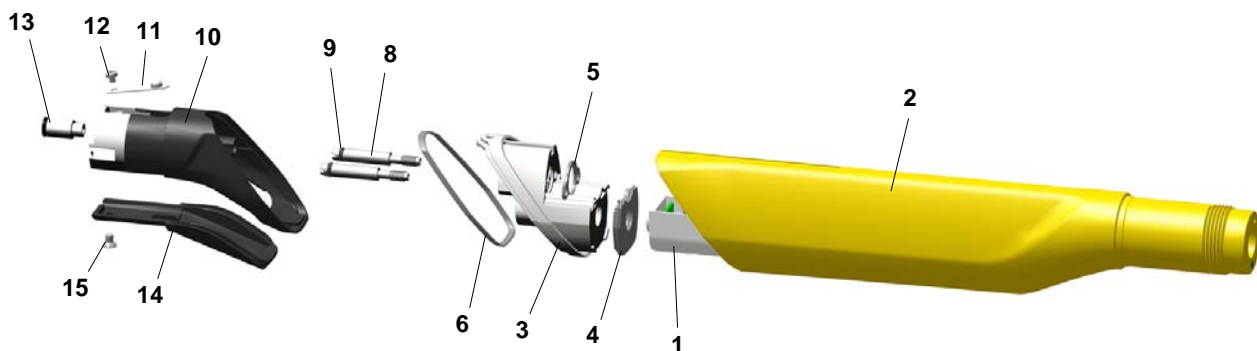

OptiGun GA03-P – shaft

OptiGun GA03-P-X – complete

OptiGun GA03-P-X Automatic powder gun - complete, polarity negative, incl. pos. 1-7

	OptiGun GA03-P-700	1010 211
	OptiGun GA03-P-900	1010 212
	OptiGun GA03-P-1100	1010 213
	OptiGun GA03-P-1300	1010 214
	OptiGun GA03-P-1500	1010 215
	OptiGun GA03-P-1700	1010 216
	OptiGun GA03-P-1900	1010 217
	OptiGun GA03-P-2100	1010 218
1	OptiGun GA03-P-X gun body – complete, see "OptiGun GA03-P-X – gun body" spare parts list	
2	Threaded sleeve – see "Nozzle combinations" spare parts list	
3	Flat jet nozzle – complete, see "Nozzle combinations" spare parts list	
4	Gun cable – complete, 20 m, see also spare parts list "Gun cable"	1008 663
5	Cable tie with Velcro closure (8x)	303 070
6	Quick release connection - NW5, Ø 6 mm, for pos. 9 (not shown)	200 840
7	Cleaning brush – Ø 12 mm (not shown)	389 765
8	Powder hose – Ø 11.5/7 mm (not shown)	1005 097#*
9	Electrode rinsing air hose – Ø 6/4 mm (not shown)	103 144*

* Please indicate length

Wearing part



OptiGun GA03-P-X – complete

OptiGun GA03-P-X – gun body

OptiGun GA03-P-X gun body – complete, polarity negative, incl. pos. 1-6

OptiGun GA03-P-700	1008 739
OptiGun GA03-P -900	1008 740
OptiGun GA03-P -1100	1008 741
OptiGun GA03-P -1300	1008 742
OptiGun GA03-P -1500	1008 743
OptiGun GA03-P -1700	1008 744
OptiGun GA03-P -1900	1008 745
OptiGun GA03-P -2100	1008 746
1 OptiGun GA03-P shaft – complete, negative polarity (see spare parts list "Shaft")	
2 Powder tube	1008 641#
3 O-ring – Ø 12x1 mm, FPM75	1006 324#
4 Ground plate	1011 457
5 SuperCorona connection	1009 764
6 Cylinder screw – M5x6 mm	263 907
Diffuser – complete (incl. pos. 8-15)	1011 635
8 Clamp ring	1008 643
9 Adaptor piece	1011 633
10 O-ring – Ø 13x1.5 mm, NBR70	1009 943
11 Fluidizing tube	1005 262#
12 Connector	1011 634
13 Screw-in nipple – M7-Ø 6 mm	1008 699
14 Plastic tube – Ø 6/4 mm	103 144*
15 Plug-in connector – Ø 6-Ø 8 mm	254 894
16 Extension tube – see "OptiGun GA03-P-X – Extension tube" spare parts list	

* Please indicate length

Wearing part

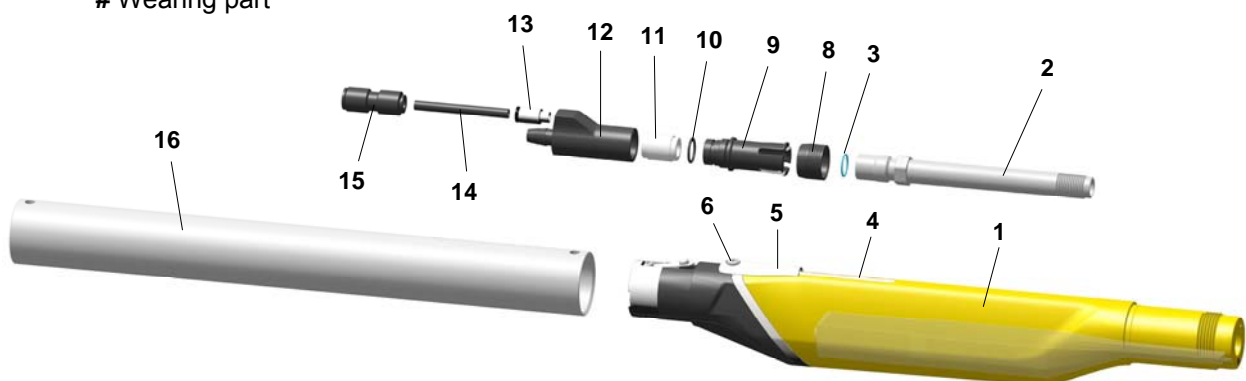

OptiGun GA03-P-X – gun body

OptiGun GA03-P-X – Extension tube

1 Extension tube for:

OptiGun GA03-P-700, L=711 mm	385 484
OptiGun GA03-P-900, L=911 mm	385 476
OptiGun GA03-P-1100, L=1111 mm	385 468
OptiGun GA03-P-1300, L=1311 mm	385 450
OptiGun GA03-P-1500, L=1511 mm	385 441
OptiGun GA03-P-1700, L=1711 mm	384 682
OptiGun GA03-P-1900, L=1911 mm	397 032
OptiGun GA03-P-2100, L=2111 mm	397 040

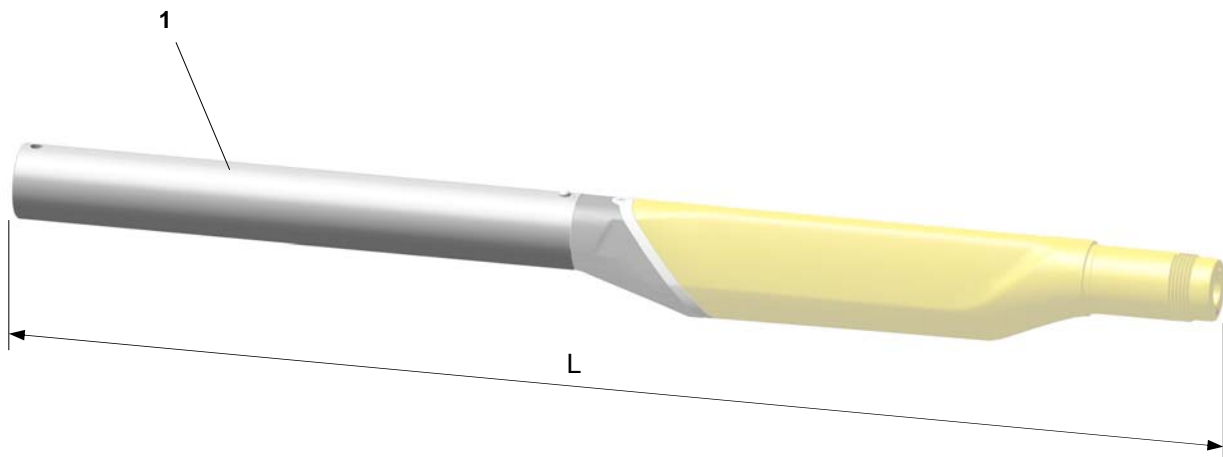

OptiGun GA03-P-X – Extension tube

Gun cable



NOTE:

If the powder gun cable is defective, it is to be completely sent in for repair!

	Gun cable – complete, 11 m	1008 661
	Gun cable – complete, 15 m	1008 662
	Gun cable – complete, 20 m	1008 663
	Gun cable – complete, 30 m	1008 664
1	Cylinder screw – M4x6 mm	1008 639
2	O-ring – Ø 9.5x1.5 mm	1008 665
3	O-ring – Ø 8.5x1 mm	1008 666

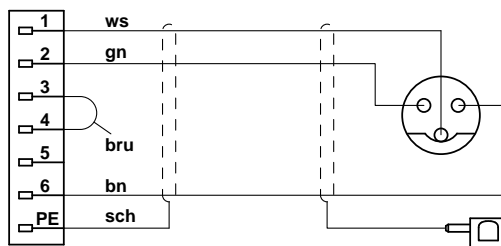

Pin allocation	
ws	white
gn	green
bru	Bridge
bn	brown
sch	Shield

Gun cable (complete)

OptiGun GA03-P – SuperCorona

1 SuperCorona ring – complete

1009 761#

Wearing part

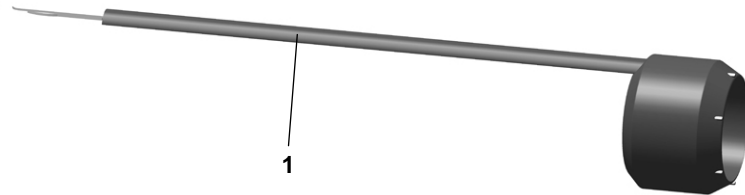

OptiGun GA03-P – SuperCorona

OptiGun GA03-P – angled nozzles

A	PA03-90° angled nozzle – complete	1009 139#
B	PA03-60° angled nozzle – complete	1009 138#
C	PA03-45° angled nozzle – complete	1009 137#
1	PA03-90° knee piece – complete	1009 135#
2	PA03-60° knee piece – complete	1009 134#
3	PA03-45° knee piece – complete	1009 133#
4	Threaded sleeve	1009 128
5	Nozzle – see "OptiGun GA03-P – accessories"	



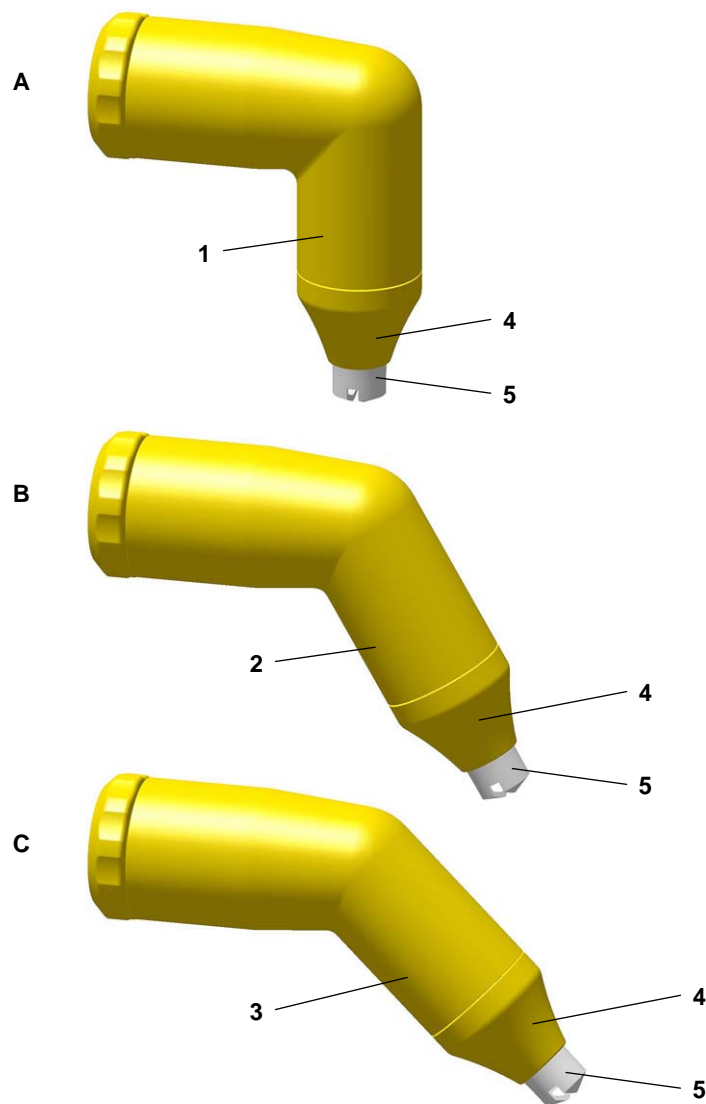



Wearing part



OptiGun GA03-P – angled nozzles



OptiGun GA03-P – accessories

OptiGun GA03-P flat jet nozzles – overview (wearing parts)







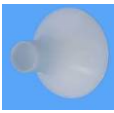

Field of application	A	B	A + B	Threaded sleeve
Profiles/flat parts (standard nozzle)	 NF27 1010 752	 1007 683	NF27 1010 754	 1007 229
Profiles/flat parts	 NF20 1007 934		NF20 1007 931	
Complex profiles and depressions	 NF21 1007 935		NF21 1007 932	
Large surfaces	 NF24* 1008 147		NF24 1008 142	 1008 326

* not suitable for angled nozzles

OptiGun GA03-P round jet nozzles – overview (wearing parts)

Field of application	A	B	A + B	Threaded sleeve	Deflectors
Suitable for large surfaces	 NS04 1008 151	 1008 152	NS04 1008 150	 1007 229	
					Ø 16 mm 331 341
					Ø 24 mm 331 333
					Ø 32 mm 331 325
					Ø 50 mm 345 822

OptiGun GA03-P gun extensions

	Gun extensions	
	L = 150 mm	L = 300 mm
without nozzle ¹	 1008 616	 1008 617
without nozzle ²	 1007 718	 1007 719
with Flat jet nozzle NF25	 1007 746	 1007 747
with Round jet nozzle NS09	 1007 748	 1007 749

¹ see NF27, NF20, NF21, NF24, NS04

² see NF25, NF26, NS09



WARNING:

It is not permitted to connect more than two extensions together, in order to prevent the gun from being damaged by arising leverage force.

- ▶ The extensions (150 mm/300 mm) may be connected TO ONLY ONE ADDITIONAL extension (150 mm/300 mm), if necessary.







OptiGun GA03-P spray nozzles for extensions – overview (wearing parts)



1007 718

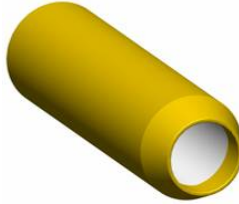

1007 719

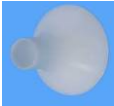
Field of application	A	B	A + B	Threaded sleeve	Deflectors
Profiles/flat parts	 NF25 1007 735	 1007 684	NF25 1007 743	 1007 740	--
Complex profiles and depressions	 NF26 1007 742		NF26 1007 744		--
Suitable for large surfaces	 NS09 1008 257	 1008 258	NS09 1008 259		 Ø 16 mm 331 341 Ø 24 mm 331 333 Ø 32 mm 331 325 Ø 50 mm 345 822

