Operating instructions and spare parts list

OptiStar CG08(-C) Gun control unit



Translation of the original operating instructions

Documentation OptiStar CG08(-C)

© Copyright 2010 Gema Switzerland GmbH

All rights reserved.

This publication is protected by copyright. Unauthorized copying is prohibited by law. No part of this publication may be reproduced, photocopied, translated, stored on a retrieval system or transmitted in any form or by any means for any purpose, neither as a whole nor partially, without the express written consent of Gema Switzerland GmbH.

Gema, EquiFlow, MagicCompact, MagicCylinder, OptiCenter, OptiFlex, OptiGun, OptiSelect and OptiStar are registered trademarks of Gema Switzerland GmbH.

ClassicLine, ClassicStandard, ClassicOpen, DVC (Digital Valve Control), GemaConnect, MagicControl, MagicPlus, MonoCyclone, MRS, MultiColor, MultiStar, OptiAir, OptiControl, OptiColor, OptiFeed, OptiFlow, OptiHopper, OptiMove, OptiSieve, OptiSpeeder, OptiSpray, PCC (Precise Charge Control), RobotGun, SIT (Smart Inline Technology) und SuperCorona are trademarks of Gema Switzerland GmbH.

All other product names are trademarks or registered trademarks of their respective holders.

Reference is made in this manual to different trademarks or registered trademarks. Such references do not mean that the manufacturers concerned approve of or are bound in any form by this manual. We have endeavored to retain the preferred spelling of the trademarks, and registered trademarks of the copyright holders.

To the best of our knowledge and belief, the information contained in this publication was correct and valid on the date of publication. Gema Switzerland GmbH makes no representations or warranties with respect to the contents or use of this publication, and reserves the right to revise this publication and make changes to its content without prior notice.

For the latest information about Gema products, visit www.gemapowdercoating.com.

For patent information, see www.gemapowdercoating.com/patents or www.gemapowdercoating.us/patents.

Printed in Switzerland

Gema Switzerland GmbH
Mövenstrasse 17
9015 St.Gallen
Switzerland

Phone: +41-71-313 83 00

Fax.: +41-71-313 83 83

E-mail: info@gema.eu.com

Table of contents

General safety regulations	3
Safety symbols (pictograms).....	3
Proper use.....	3
Product-specific safety measures	4
OptiStar CG08 Gun control unit.....	4
About this manual	5
General information	5
Software version	5
Product description	7
Field of application	7
Technical data	8
OptiStar CG08 - versions.....	8
Connectable guns	8
Electrical data	8
Pneumatic data	9
Dimensions	9
Powder output (guide values)	9
Air flow rates	10
Design and function	11
General view	11
Operating elements.....	12
Input keys and switches.....	14
Connections	15
Pin assignment	16
CG08-C pin assignment.....	16
Scope of delivery	16
Typical properties – Characteristics of the functions	17
Operating modes	17
Rinsing mode	18
Monitoring of wearing parts.....	19
Keyboard lock	20
Background illumination.....	20
Correction factor for the powder output	21
Commissioning	23
Preparation for start-up	23
Basic conditions	23
Mounting instructions	23
Connection instructions.....	24
Initial start-up	27
System parameters.....	27
Entering the system parameters	27
Operation	31

Select predefined operating mode (Preset mode)	31
Starting the user-defined operating mode (Program mode).....	31
Setting powder output and powder cloud	32
Setting the electrode rinsing air	33
Correction values.....	33
Entering the correction values	33
Powder output/powder hose correction.....	34
Correction factor - diagram.....	36
Cleaning mode	37
Activating the cleaning function.....	37
Monitoring of wearing parts and trigger counter.....	38
Trigger counter	38
View remaining service life	39
Deactivation of wearing part monitoring.....	40
Setting the background illumination	40
Activate/deactivate the keyboard lock	41
Checking the software version	41
RAM Reset	41
Shutdown.....	42
If in disuse for several days	42
CAN bus	43
Hardware	43
CAN bus cable - plug assignment	44
System release in network operation	44
Determining user address (Node-ID) and Baud rate.....	44
Fault remedying	47
Error diagnosis of the software.....	47
General information	47
Help codes.....	47
Help codes list	49
Appearance of errors.....	49
Spare parts list	51
Ordering spare parts.....	51
OptiStar CG08(-C) Gun control unit	52
OptiStar CG08(-C) – Front plate and power pack.....	53
OptiStar CG08(-C) – inside rear wall.....	54
OptiStar CG08(-C) connections.....	55

General safety regulations

This chapter sets out the fundamental safety regulations that must be followed by the user and third parties using the OptiStar CG08(-C) Gun control unit.

These safety regulations must be read and understood before the OptiStar CG08(-C) is put into operation.

Safety symbols (pictograms)

The following warnings with their meanings can be found in the Gema Switzerland operating instructions. The general safety precautions must also be followed as well as the regulations in the operating instructions.

**DANGER!**

Danger due to electrically live or moving parts. Possible consequences: death or serious injury

**WARNING!**

Improper use of the equipment could damage the machine or cause it to malfunction. Possible consequences: minor injuries or damage to equipment

**INFORMATION!**

Useful tips and other information

Proper use

1. The OptiStar CG08(-C) is built to the latest specification and conforms to the recognized technical safety regulations and is designed for the normal application of powder coating.
2. Any other use is considered non-compliant. The manufacturer shall not be liable for damage resulting from such use; the user bears sole responsibility for such actions. Gema Switzerland GmbH must be consulted prior to any use of the OptiStar CG08(-C) for any purposes or substances other than those indicated in our guidelines.

3. Observance of the operating, service and maintenance instructions specified by the manufacturer is also part of conformity of use. The OptiStar CG08(-C) should only be used, maintained and started up by trained personnel, who are informed about and are familiar with the possible hazards involved.
4. Start-up (i.e. the execution of intended operational tasks) is forbidden until it has been established that the OptiStar CG08(-C) has been set up and wired according to the guidelines for machinery (2006/42 EC). EN 60204-1 (machine safety) must also be observed.
5. Unauthorized modifications to the OptiStar CG08(-C) exempt the manufacturer from any liability from resulting damage.
6. The relevant accident prevention regulations, as well as other generally recognized safety regulations, occupational health and structural regulations are to be observed.
7. Furthermore, the country-specific safety regulations also must be observed.

Product-specific safety measures

- Installation work performed by the customer must be carried out according to local regulations.
- All components must be grounded according to the local regulations before start-up.

OptiStar CG08 Gun control unit

The OptiStar CG08(-C) Gun control unit is a constituent part of the equipment and is therefore integrated in the system's safety concept.

If it is to be used in a manner outside the scope of the safety concept, then corresponding measures must be taken.



NOTE:

For further security information, see the more detailed Gema safety regulations!

About this manual

General information

This operating manual contains all the important information you require for the working with the OptiStar CG08(-C) Gun control unit. It will safely guide you through the start-up process and give you references and tips for the optimal use of your new powder coating system.

Information about the functional mode of the individual system components - booth, gun and powder injector - should be referenced in the respective enclosed documents.



DANGER:

Working without operating instructions

Working without operating instructions or with individual pages from the operating instructions may result in damage to property and personal injury if relevant safety information is not observed.

- ▶ Before working with the device, organize the required documents and read the section "Safety regulations".
 - ▶ Work should only be carried out in accordance with the instructions of the relevant documents.
 - ▶ Always work with the complete original document.
-

Software version

This document describes the operation of the OptiStar CG08(-C) Gun control unit with software version starting from 2.00 (see also "Software version request")!

Product description

Field of application

The OptiStar CG08(-C) Gun control unit is designed exclusively for controlling the Gema powder coating guns (see also in chapter "Technical data").

Any other use is considered non-compliant. The manufacturer is not responsible for any incorrect use and the risks associated with such actions are assumed by the user alone!

For a better understanding of the interrelationships in powder coating, it is recommended that the operating instructions for all other components be read as well, so as to be familiar with their functions too!



OptiStar CG08(-C) Gun control unit

Reasonably foreseeable misuse

- Operation without the proper training
- Use with insufficient compressed air quality and grounding
- Use in connection with unauthorized coating devices or components

Technical data

OptiStar CG08 - versions

OptiStar	CAN bus
CG08	no
CG08-C	yes

The equipment designation is indicated on the type plate.

Connectable guns



OptiStar CG08(-C)	connectable
OptiGun GA03	yes



WARNING:

The OptiStar CG08(-C) gun control unit may only be used with the specified gun types!

Electrical data

OptiStar CG08(-C)	
Nominal input voltage	100-240 VAC
Frequency	50-60 Hz
Connected load	40 VA
Nominal output voltage (to the gun)	12 V
Nominal output current (to the gun)	1.2 A
Protection type	IP54
Temperature range	0 °C - +40 °C (+32 °F - +104 °F)
Max. surface temperature	85 °C (+185 °F)
Approvals	  0102 II 3 (2) D PTB11 ATEX 5007-2

Pneumatic data

OptiStar CG08(-C)	
Compressed air connection	Quick coupling
Input pressure (must be set in the system parameter P2)	5.5 bar 6.0 bar 6.5 bar
Max. input pressure	10 bar / 145 psi
Min. input pressure (while unit in operation)	5.5 bar / 80 psi
Max. water vapor content of the compressed air	1.3 g/m ³
Max. oil vapor content of the compressed air	0.1 mg/m ³

Dimensions

OptiStar CG08(-C)	
Width	173 mm
Depth	250 mm
Height	177 mm
Weight	approx. 3.7 kg



Powder output (guide values)

General conditions for the OptiFlow Injector

Powder type	Epoxy/polyester
Powder hose length (m)	12
Powder hose Ø (mm)	11
Power hose type	POE with guide strips
Input pressure (bar)	5.5
Correction value C0	Powder output zeroing adjustment

Guide values for OptiStar CG08 with OptiFlow Injector IG06

All values in these tables are guide values. Differing environmental conditions, wear and different powder types can affect the table values.

Total air 		3 Nm ³ /h	4 Nm ³ /h	5 Nm ³ /h
		Powder output (g/min)		
Powder output  (%)	20	60	70	80
	40	115	140	160
	60	175	210	220
	80	220	260	270
	100	250	300	310

Air flow rates

The total air consists of conveying air and supplementary air, in relation to the selected powder quantity (in %). As a result the total air volume is maintained constant.

OptiStar CG08(-C)	
Conveying air flow rate	0-5.4 Nm ³ /h
Supplementary air flow rate	0-4.5 Nm ³ /h
Electrode rinsing air flow rate	0-3.0 Nm ³ /h



NOTE:

The total air consumption for the device is determined based on the 3 configured air values.

These values apply for an internal control pressure of 5.5 bar!



NOTE:

The max. total air consumption during the coating operation is < 5.5 Nm³/h:

- ▶ Total air = 5 Nm³/h (Conveying air + Supplementary air)
- ▶ Electrode rinsing air = 0.1 Nm³/h (flat jet nozzle)

Design and function

General view



- 1 Front plate with control and display elements
- 2 Enclosure

- 3 Back panel with interfaces

Operating elements

Display and input buttons



NOTE:

For easier operation of the control unit, the preset and actual values are distributed across several levels. The "sel" key is used to switch between the levels. If no controls are used within 6 s, the device automatically returns to level 1.

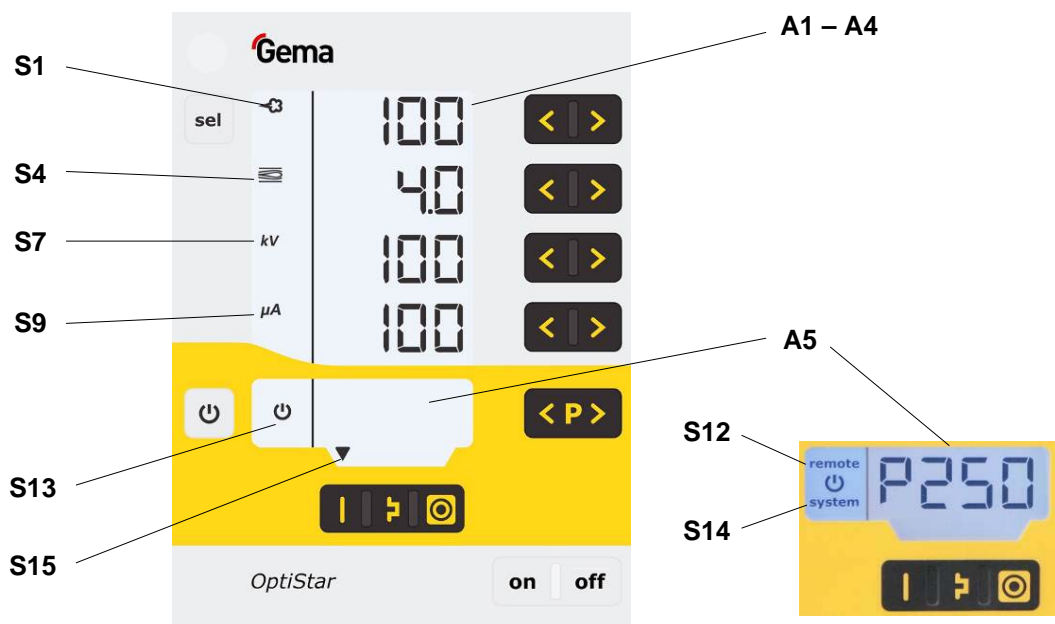

Displays, Level 1

Designation	Function
A1-A4	Display of actual values, desired values and system parameters Flashes when the possible range is exceeded.
A5	Display of program numbers, error diagnosis codes and status information
S1	Powder output (display in %)
S4	Total air volume (display in Nm ³ /h)
S7	High voltage (display in kV)
S9	Spraying current (display in μA)
S12 remote	Remote operation mode, no local operation possible Remote operation mode is used as keyboard lock, reduced operation is possible
S13	Gun release
S14 system	System release in network operation
S15	Display of predefined operating modes or display of cleaning mode during cleaning

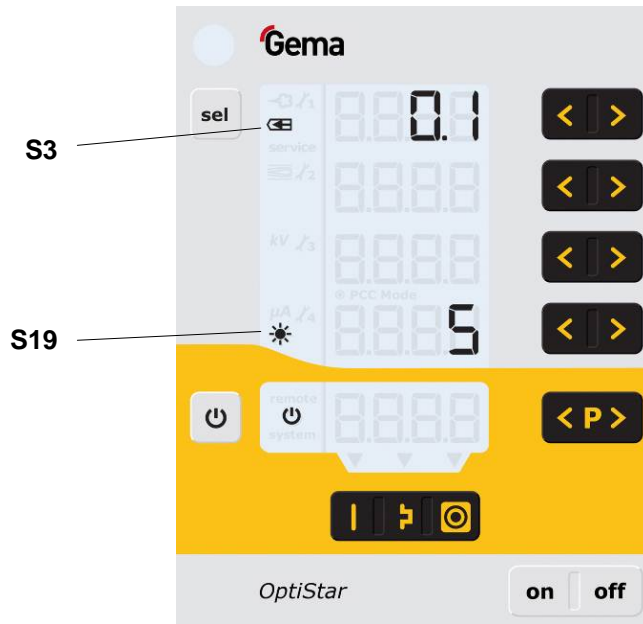

Displays and LEDs, Level 2

Designation	Function
S3	Electrode rinsing air (display in Nm ³ /h)
S19	Display illumination (0-8)

Input keys and switches

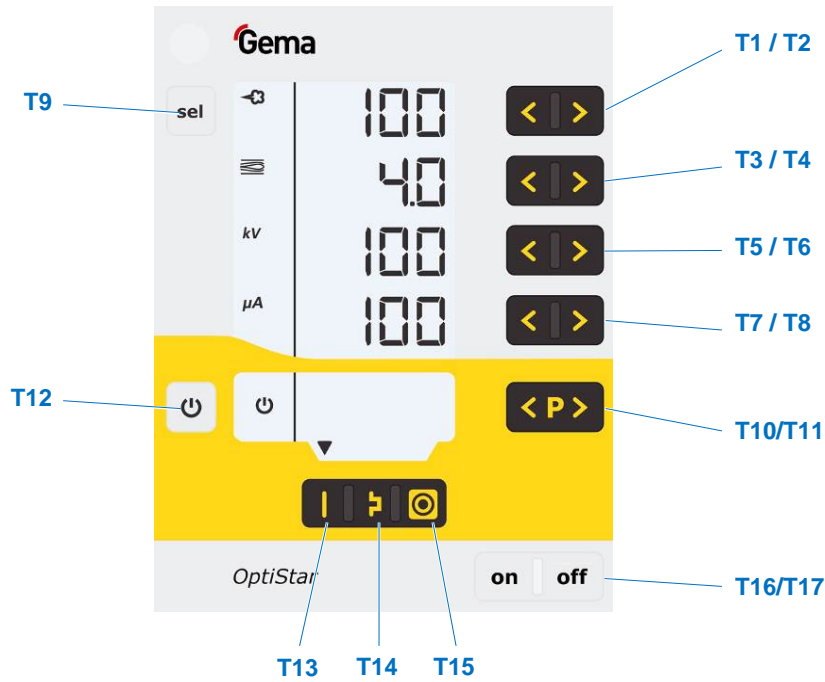

Input keys and switches





Designation	Function
T1-T8	Input keys for desired values and system parameters
T9 (Select)	Switch between display levels
T10-T11	Program change
T12	Gun release Switchover to system parameter mode (Press for at least 5 secs.)
T13	Preset mode for flat parts (fixed values)
T14	Preset mode for complex parts with depressions (fixed values)
T15	Preset mode for overcoating parts already coated (fixed values)
T16/T17	Power switch On/Off

Connections

Compressed air hoses / cables



OptiStar CG08-C – Connections - Compressed air hoses / cables

Connection	Description
1.1 Main air IN	Compressed air connection
2.1 Power IN	Mains cable connection
2.2 Gun	Gun cable connection
2.3 Aux	CAN bus connection (IN)
2.4 Aux	CAN bus connection (OUT)
1.4	Electrode rinsing air connection 
1.3	Supplementary air connection 
1.2	Conveying air connection 
	Grounding connection 

Pin assignment

Power IN

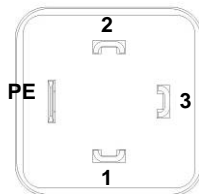

Power IN connection

- 1 Neutral conductor (power supply)
- 2 Phase (100-240 VAC)
- 3 System input ON/OFF (100-240 VAC)
- PE Grounding PE

Gun

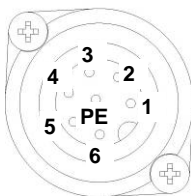

Gun connection

- 1 Ground
- 2 Remote control 1 (GM03)
- 3 Ground
- 4 Trigger
- 5 Remote control 2 (GM03)
- 6 Oscillator
- 7 Grounding PE

CG08-C pin assignment

Aux

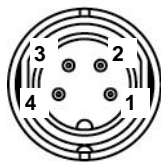

CAN IN plug with 4 pins (2.3 Aux)

- 1 Ground
- 2 24 VDC
- 3 CAN high
- 4 CAN low
- Enclosure - shield

2.3

Aux



CAN OUT socket with 4 pins (2.4 Aux)

- 1 Ground
- 2 24 VDC
- 3 CAN high
- 4 CAN low
- Enclosure - shield

2.4

Scope of delivery

- Mains cable
- Quick start instructions and operating manual

Typical properties – Characteristics of the functions

Operating modes

The OptiStar CG08(-C) gun control unit has two operating modes.

Predefined operating mode (Preset mode)

The OptiStar CG08(-C) gun control unit has three preset application modes:

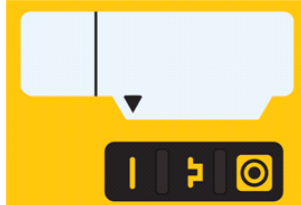

- **Application mode for flat parts** 

This application mode is suitable for the coating of simple, flat workpieces without larger cavities.
- **Application mode for complex parts** 

This application mode is suitable for the coating of three-dimensional workpieces with complex shapes (e.g. profiles).
- **Application mode for recoating parts already coated** 

This application mode is suitable for the overcoating of workpieces which are already coated.

In this operating modes, current (μA) and high voltage (kV) are preset, while powder and air volumes can be set and stored for each application mode.

Adjustable operating mode (Program mode)

In this operating mode, 250 individually definable programs (P001-P250) are available. These programs are automatically saved and can be recalled again as the application requires.



The values for current, high voltage, powder output, total air and electrode rinsing air can be set as needed for a given application.



NOTE:

The settings defined in the 250 programs and 3 application modes are automatically stored, without confirmation!

Precise Control of spraying Current (PCC Mode)

For coating components with both complex and simple geometries, a spraying current of below 10 μA can be selected to prevent unintended overcoating on the simpler surfaces. This is especially important in combination with high loading powders (such as metallic). The controller automatically switches into "PCC mode". This allows for very fast yet highly precise control. The high voltage and spray current values and their symbols are depicted in red:

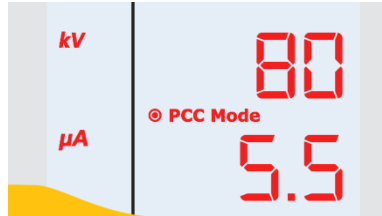

Rinsing mode

The PowerClean mode is used to blow powder accumulations and moisture out of the powder hose, injector, and gun using compressed air.



NOTE:

The rinsing mode can only be activated from standby mode, namely by pressing the corresponding keys on the gun control unit or also by an optional bus connection such as CAN bus.

The rinsing mode is signaled by a circling LCD segment on the display:



The actual rinsing procedure is started and stopped by the superordinated control unit.

Once the rinsing mode is quit, the unit automatically returns to the last program.

Monitoring of wearing parts

Wearing parts have a limited service life. The OptiStar CG08(-C) gun control unit offers functionality to monitor the service life of up to four wearing parts using a reverse counter:



NOTE:

The order of wearing parts to be monitored as well as the service life can be set as needed by the operator.

Example table:

No.	Wearing part
1	Insert sleeve
2	Powder hose
3	Electrode holder
4	Pulverizing element

To better explain this function, a few terms relevant to this process must first be explained:

Service life	Operating time after which wearing parts should be replaced (defined by the operator).
Minus days	Number of hours past the selected service life that the wearing part has continued to be used.
Operating life	Effective time during which the wearing part was in operation = service life plus minus days, if any
Remaining service life	displayed value (where not in the minus range)

- The service life monitoring can be activated/deactivated for each wearing part (see also "Initial start-up - Monitoring of wearing parts")
- By default all monitoring is deactivated and must be activated by the operator
- Query the remaining service life
- Reset the operating time
- Unit used for display of service life / operating time: 1 day (x.x), range: 0.1 – 500 days

Keyboard lock

The OptiStar CG08(-C) gun control unit has a keyboard lock to prevent modification of individual parameter values (kV, μ A etc.) within the operating modes (Program and Preset). Following is not affected by the keyboard lock:

- Program selection
- Display of desired values of the current program
- Displaying the actual values
- Error acknowledgement

An active keyboard lock is indicated by a blinking of the **remote** display. (see also "Initial start-up - Activate/deactivate the keyboard lock")



The keyboard lock status remains stored, when switching the equipment off and on. The keyboard lock is cancelled if a RAM reset is performed. On the OptiStar CG08(-C) gun control unit (automatic device), an external interlocking by remote input can also take place. These two locking features are independent, which means, if the local interlocking is deactivated, the external interlocking remains activated and vice versa.

Background illumination

Brightness

8 different brightness settings are available for the display. The setting remains in place when the machine is switched on/off.

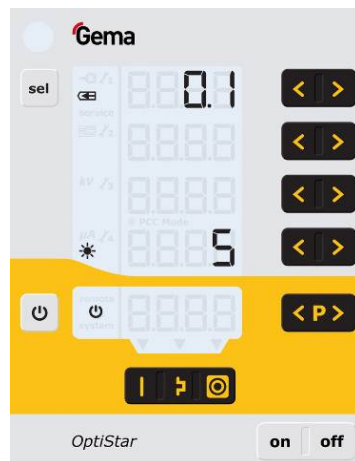

Auto Power Save mode

If no powder is being applied, then the background lighting turns off automatically 5 minutes after a button has been pressed last time.

Correction factor for the powder output

The OptiStar CG08(-C) gun control unit enables a zeroing out of the powder output. This allows for compensation to different powder hose lengths connecting to the pistol.

The correction factor C0 can be selected such that no powder is output when the powder share is reduced to 0%. (see also "Initial start-up - Setting correction factor for powder output")

Commissioning

Preparation for start-up

Basic conditions

When starting up the OptiStar CG08(-C) gun control unit, the following general conditions impacting the coating results must be taken into consideration:

- Gun control unit correctly connected
- Gun correctly connected
- Corresponding power and compressed air supply available
- Powder preparation and powder quality

Mounting instructions

The OptiStar CG08(-C) gun control unit is mounted into place using 2xM6 screws on the front side.



Connection instructions

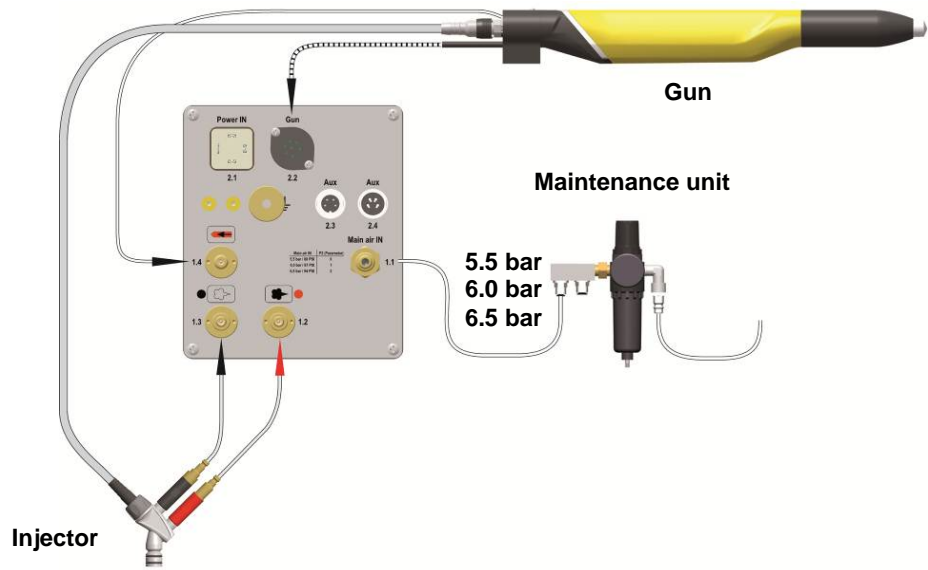

Connection instructions - overview



1.



2.



NOTE:

Use clamp to connect grounding cable to the cabin or the suspension arrangement. Check ground connections with Ohm meter and ensure 1 MOhm or less!



3.



4.



5.



6.



NOTE:
The compressed air must be free of oil and water!

Initial start-up



NOTE:

The gun control unit always starts up to the last configured settings.

System parameters

The OptiStar CG08(-C) Gun control unit is configured by using the system parameters. This configuration will be saved in the equipment memory. These values can be adjusted and requested manually or by remote interface (CAN).

Entering the system parameters

1. Turn on the gun control unit with the **ON** key
2. Hold  key down for 5 seconds
The display switches to the following level:

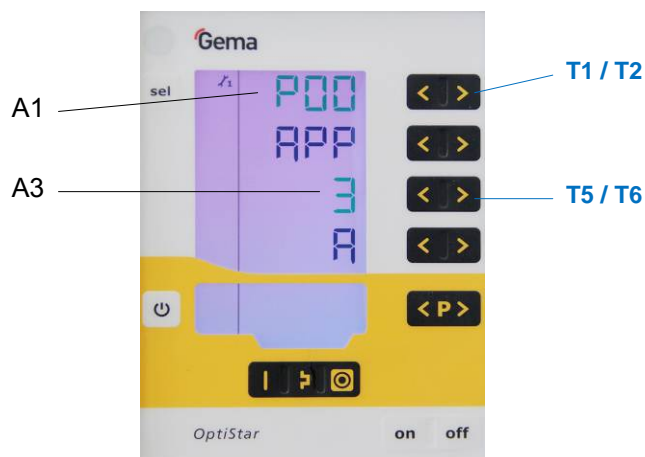

3. The system parameter number is shown in the display **A1** with a **P** placed in front
4. Set the corresponding system parameter value with the **T5** or **T6** key.
The value of the adjusted system parameter appears on corresponding display **A3**
5. Browse to the next or previous system parameter with the **T1** or **T2** key

6. Select parameter values according to the following table

No.	Description	Values	Display
P00 ¹⁾	Device type	0: Fluidizing device Type F (CG13)	F
		1: Box device with vibrator Type B (CG13)	B
		2: Stirrer device Type S (CG13)	S
		3: Automatic device (CG08/C)	A
		4: Manual device with fluidization (CG13)	S Fd
		5: Application pump (CG11-P)	P
		6: Application pump + CAN-Bus (CG12-CP)	CP
P02	Input pressure	0: P in = 5.5 bar 1: P in = 6 bar 2: P in = 6.5 bar	5.5 6.0 6.5
P03	Unit of measurement (air)	0: Nm³/h 1: scfm	
P04	Interface type	0: Deactivated 1: Automatic recognition	OFF Auto
P05	CAN Baud rate	0: 20 kBit/s 1: 50 kBit/s 2: 100 kBit/s 3: 125 kBit/s 4: 250 kBit/s 5: 500 kBit/s 6: 800 kBit/s 7: 1 MBit/s	2 0 5 0 1 0 0 1 2 5 2 5 0 5 0 0 8 0 0 1 0 0 0
P06	CAN Node ID	1-127	
P07	Reserve		
P08	Reserve		
P09	Reserve		
P10	Log level	0, 1, 2 , 3, 4, 5	LoG

¹⁾ is not overwritten, if a Memory Reset is performed

Default values are marked by **bold** print.

7. Press  key to quit the system parameter mode
The display switches to the standard level

System parameter P00

If the OptiStar CG08(-C) gun control unit is equipped with the CAN bus-option, this device type is recognized automatically. The system parameter P00 is set to **3** when device is starting.



NOTE:



A wrong parameterization leads to various malfunctions!

▶ The system parameter P00 must be set to 3 (Automatic device)!

System parameter P03



This parameter is used to determine the measuring unit for all airs (total air and electrode rinsing air). If the parameter is set to **1 (scfm)**, then all air values are shown in this measuring unit. These lines are displayed in **blue**.

System parameter P10

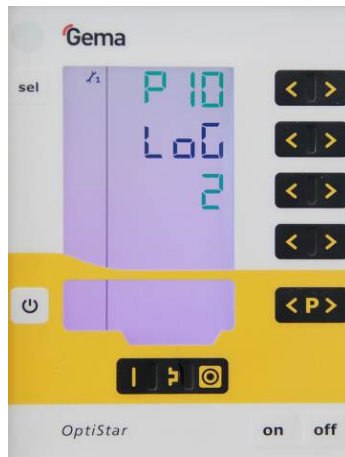

The device can export log reports of the program run to an SD card for test purposes and for finding defects.

If an SD card is inserted during the switching on procedure, the log messages are also recorded onto the SD card. The data are record in the MESSAGES.LOG file in the root directory. Once this file reaches a size of 32 MB, it is renamed as MESSAGES.1 and a new MESSAGES.LOG file is then created.

Parameter value	Level of detail of reports
0	no messages
1	few details
...	
5	all messages



NOTE:

Real time timings can be impaired from a level of detail of 4.

Operation



NOTE:



During the initial commissioning of the device, it is recommended that the functional check be performed without powder!

Select predefined operating mode (Preset mode)

1. Turn on the gun control unit with the **ON** key
2. Press the corresponding application key
the arrow above the pressed key is switched on



The pre-defined application modes have preset values for high voltage and spray current:

Application mode	Preset μA	Preset kV
 (flat parts)	100	100
 (complex parts)	22	100
 (overcoated)	10	100

3. The air values for total air, powder output and electrode rinsing air can be individually defined and are saved in the programs.

Starting the user-defined operating mode (Program mode)

1. Turn on the gun control unit with the **ON** key
2. Press  program key
3. Select desired program (001-250)

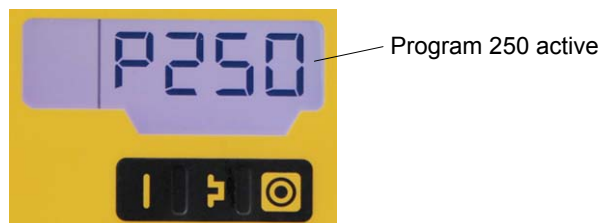





4. Change coating parameters as required



NOTE:

Programs 001-250 are preset at the factory but can be modified at any time, after which they are automatically stored.

Description	Presetting
Powder output 	0 %
Total air 	0 Nm ³ /h
High voltage 	0 kV
Spray current 	0 µA
Electrode rinsing air 	0.1 Nm ³ /h

Setting powder output and powder cloud

The powder output depends on the selected powder output (in %) and the selected total air volume.

Setting the total air volume



1. Adjust the total air volume with the **T3/T4** keys (see also the gun / injector operating manual)
 - Adjust the total air volume according to the corresponding coating requests

Setting the powder output



1. Adjust the powder output volume (e.g. according to the desired coating thickness)
 - Factory default setting of 50% is recommended for initial operation. The total air volume is thereby kept constant automatically by the control unit.





NOTE:

As a factory default value, a powder rate of 50% and a total air volume of 4 Nm³/h are recommended.

By inserting values, which the equipment cannot execute, the operator is made aware by flashing of the appropriate display and a temporary out of range message!

2. Check fluidization of the powder in the powder container
3. Point the gun into the booth, press the gun trigger and visually check the powder output

Setting the electrode rinsing air

-  Press the key **T9 (SELECT)**
The second display level will be shown
- 
 Adjust the correct electrode rinsing air according to the applied nozzles (deflector plate, flat jet nozzle)



NOTE:

By using flat jet nozzles, the factory default value is approx. 0.3 Nm³/h, by using round jet nozzles with air-rinsed deflector plates, the factory default value is approx. 0.5 Nm³/h!

- If in this display level is no operation for 3 seconds, the first display level is switched over independently

Correction values

The OptiStar OptiStar CG08(-C) Gun control unit can be adapted with the correction values optimally to local conditions (e.g. the adjustment of different powder outputs in the plant).

Entering the correction values

- Hold  key down for 5 seconds
The display switches to the following level:



- Press  key
The display switches to the following level:

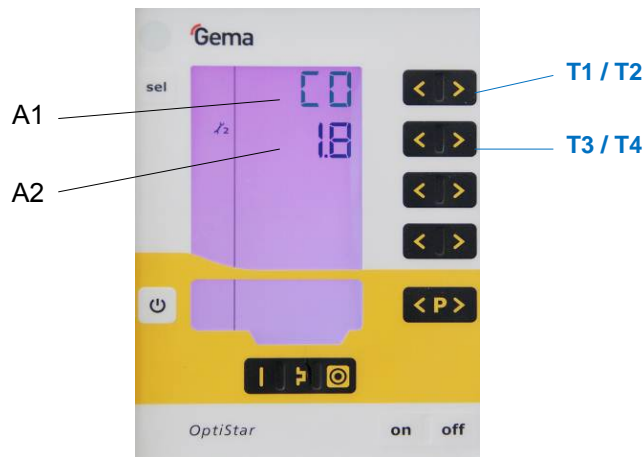

3. The correction factor number is shown in the display **A1** with a **C** placed in front
4. Set the corresponding correction value with the **T3** or **T4** key. The value of the adjusted correction factor appears on corresponding display **A2**
5. Browse to the next or previous correction factor with the **T1** or **T2** key
6. Select correction values according to the following table

Corr.-value	Description	Range ²⁾	Default value
C0	Powder output (dm ³ /h)	50-30	1.8 ¹⁾
C1	Powder hose correction value (%)	40-100	100
C2	Daily correction value (%)	50-150	100

1) Any value correction is set to its default value if the default value changes when the P00 device type is changed.

2) A correction value is set to its default value if it is outside of the value range after the P00 device type has been changed.

7. Press  key
Display returns to the first level display.

Powder output/powder hose correction



NOTE:

The settings in the following example are carried out for each gun individually!

Powder output corrections are made at the first start-up, after a service work, after the solution of application problems, or by using different hose diameters!

It is recommended to create a table with input fields (see "Example table for powder output/powder hose correction"), so that, if a possible system reset takes place, an access to these data can take place.

Procedure (powder output correction)

1. Set the total air to **4.0** (Nm³/h) on the **A2** display. Set the powder output to **00** (%) on the **A1** display



2. To enter the system parameter mode, press the key **T12** longer than 5 seconds.
3. Press  key
The display switches to the correction factors level: The correction factor number is shown in the display **A1** with a **C** placed in front
4. Check the correction value for minimum powder output **C0** on the **A2** display, and set it to **1.8** (Nm³/h) with the keys **T3/T4**, if necessary.
5. Check the correction value for maximum powder output **C1** on the **A2** display, and set it to **100** (%), if necessary.

For the next steps a measuring bag is necessary, for weighing the powder output. Do not forget to note the dead weight of the measuring bag.

6. Put the measuring bag over the gun nozzle and fasten it. Switch on the gun for 60 seconds
7. After this time has elapsed, switch off the gun, remove the measuring bag and weigh it. The powder output should be between 10-15 gr
8. If no powder is expelled from the gun, return to the system parameter mode and increase the minimum powder output value **C0** (range **0.5-3.0** Nm³/h)
9. If too much powder is expelled from the gun, return to the system parameter mode and decrease the minimum powder output value **C0** (range **0.5-3.0** Nm³/h)
10. Repeat steps 6 and 7, until the powder output amounts to 10-15 g. Annotate the adjusted minimum powder output value **C0** in the table



Exit the system parameter mode by pressing the key **T12**.

Procedure (powder hose correction)

1. Set the powder output value to **80** (%) on the **A1** display
2. Put the measuring bag over the gun nozzle and fasten it. Switch on the gun for 60 seconds
3. Switch off the gun after 60 seconds, remove the measuring bag and weigh it
4. Annotate the powder output in **g/min** in the table

Calculate the powder output correction according to following formula:

$C1 (\%) = \frac{\text{smallest powder output}}{\text{measured powder output}} \times 100$
--

5. Annotate the calculated values (**C1**) for each individual gun in the table and enter the values to the control unit (therefore, repeat the steps 2 and 3)

Example table for powder output/powder hose correction

Gun No.	Powder output correction C0			
	before correction		after correction	
1	C0=1.8 Nm ³ /h	20 gr.	C0=1.7 Nm ³ /h	12 gr.
2	C0=1.8 Nm ³ /h	10 gr.	C0=1.8 Nm ³ /h	13 gr.
3	C0=1.8 Nm ³ /h	0 gr.	C0=2.6 Nm ³ /h	12 gr.
etc.				

Gun No.	Powder hose correction C1			
	before correction		after correction	
1	C1=100%	200 gr.	C1=100%	200 gr.
2	C1=100%	250 gr.	C1=80%	200 gr.
3	C1=100%	280 gr.	C1=71%	200 gr.
etc.				

Correction factor - diagram

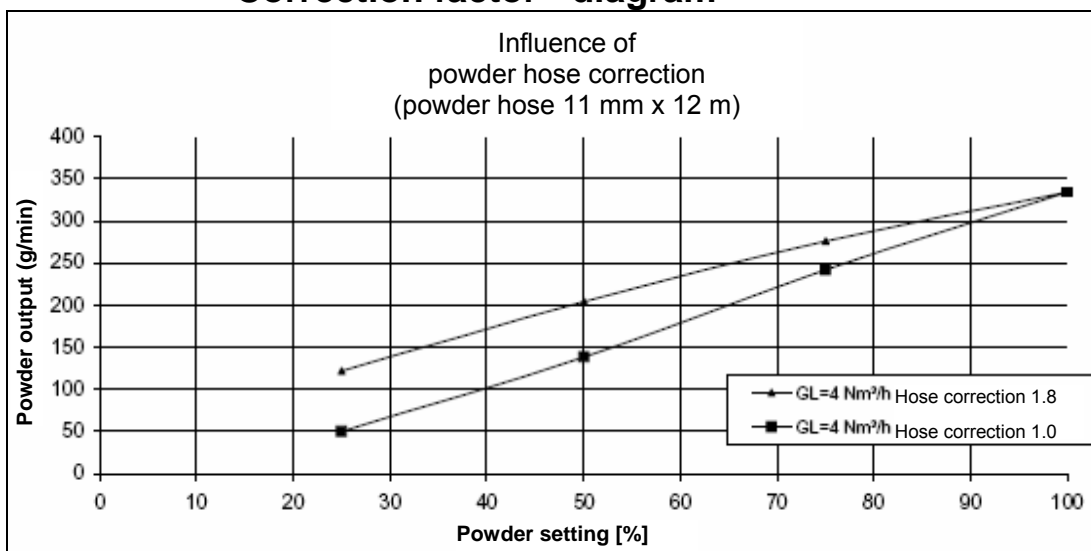

Correction factor - diagram



NOTE:

The hose length correction factor is chosen in such a way, that no powder is visible if the powder portion is 0%, by increasing the value, the powder becomes visible then. This performance depends on the hose length and the hose diameter!

Daily correction value C2



NOTE:

The daily correction value C2 can be used to allow higher or lower powder volumes!

Cleaning mode

The cleaning mode enables blowing off powder accumulations in the powder hose with preset air pressure. This function is a two steps process to activate.

The powder hose cleaning mode can be activated also by an optional bus connection such as CAN bus.



NOTE:

The injector must be disconnected prior to cleaning procedure!



Activating the cleaning function

The cleaning mode can only be activated from standby mode (main menu display, no powder conveying). The prerequisite is, that all necessary release signals are present.



1.

2. Select the cleaning function

Key	Cleaning function
	Powder hose cleaning with increasing air volume
	Powder hose cleaning with constant air volume

The symbol S15 or S16 of the selected function is displayed in blue

3. During the mode „Powder hose cleaning with increasing air volume“ all airflows are increased step by step after starting the cleaning procedure, and then they remain at the maximum:

Time	[s]	0	1	2	3	4...
Conveying air	[Nm ³ /h]	0	2	4	5.5	5.5
Supplementary air	[Nm ³ /h]	0	1.5	3.0	4.5	4.5
Electrode rinsing air	[Nm ³ /h]	0	1.0	2.0	3.0	3.0

4. During the mode „Powder hose cleaning with constant air volume“, there is no airflows increasing step by step. The maximum values are set immediately.

The cleaning mode is exited:

- if no operation is started within 15 s (not in Remote operation mode)
- if the cleaning sequence has finished





The active cleaning function is terminated immediately when exiting this mode.

The cleaning mode is terminated by pressing the  key.

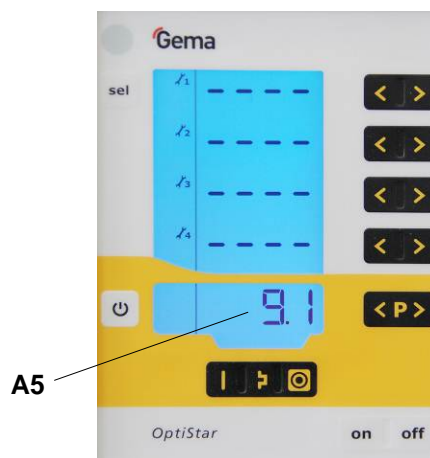
Monitoring of wearing parts and trigger counter

1. Press  key 2x
The display switches to the following level: The display switches to the following level:



2. Press  and  at same time
Monitoring is activated
During the first activation a value of 1 is shown as the start value. If monitoring has already been activated at some earlier point, then the last stored value is displayed.
3. Set the desired service life for each wearing part using the  or 
4. The reverse counter is then activated and runs only during active coating
5. If the selected service life is exceeded, the **service** symbol appears on the display. The coating procedure is not affected by this.

Trigger counter

The trigger counter (total time in days of trigger time) is shown in the display **A5**.

The trigger counter can't be reset!

View remaining service life

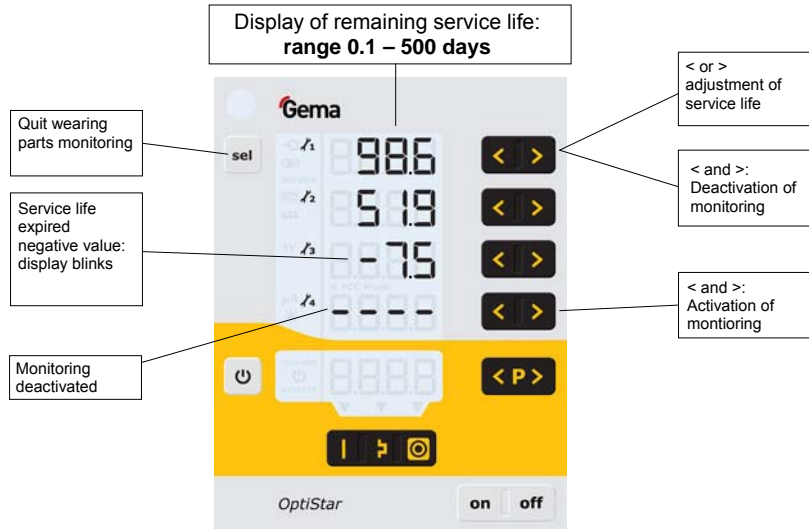

1. Press **sel** key 2x
The display switches to the wearing part monitoring level



Display example for wearing part no. 3:

Read minus days	-7.5 days
Selected service life	200 days
Operating life	207.5 days

Deactivation of wearing part monitoring

1. Press  and  key simultaneously
Monitoring is deactivated.

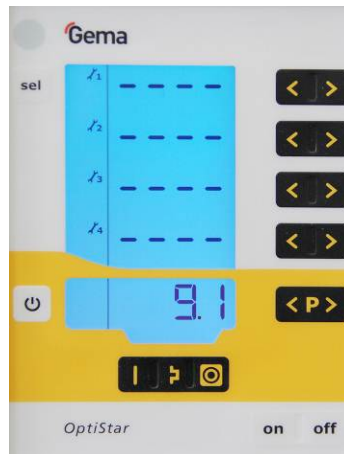

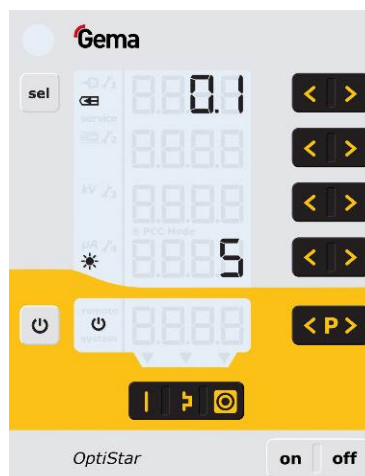

Setting the background illumination

1. Press  key
The display switches to the following level:



2. 
Select the desired brightness

Activate/deactivate the keyboard lock

1. Hold  key pressed
2. Press  key
The keyboard lock is activated. The **remote** display blinks.
3. The keyboard lock is cancelled by pressing the same key combination

Checking the software version

4. Press these two keys at the same time



- 5.

The status display is shown as long as the keys are held.

RAM Reset

The RAM reset enables a restore of factory settings of the OptiStar CG08 gun control unit. All parameters (**except P00**) and correction values as well as all user-defined values in the Program mode and Preset mode will be overwritten with factory default. An active keyboard lock will be deactivated.

NOTE:

By resetting the RAM, all user-made settings will be set to factory default!

1. Switch off the control unit
2. Press the  key and hold it
3. Switch on the control unit, the **CLR** display blinks



4. Wait for approximately 5 seconds, until **CLR** disappears
5. Release the  key

6. All values are reset. The control unit must be set-up again.

Shutdown



1. Release gun trigger
2. Switch off the control unit

NOTE:

The adjustments for high voltage, powder output volume and electrode rinsing air remain stored

If in disuse for several days

1. Separate from power mains
2. Clean the coating equipment (see the corresponding operating manual)
3. Turn off the compressed air main supply

CAN bus

The OptiStar CG08-C Gun control unit, fitted with a CAN bus interface, is a simple CANopen slave. It operates in a network with a central control unit (Master). Communication takes place exclusively between the Master and the Slaves.



CAN bus interface

Following data can be accessed by CANopen:

- All desired values (process data)
- All actual values (process data)
- All control values
- All system parameters (except Baud rate and CAN address)
- All error messages
- All special parameters such as software version, daily correction, powder output correction etc.

Hardware

The OptiStar control units are connected to the central PLC control unit via 4 pin CAN bus cables. The last bus client is fitted with a terminal plug with terminal resistor in order to terminate the network correctly. A maximum of up to 127 OptiStar Control units can be operated in a network.

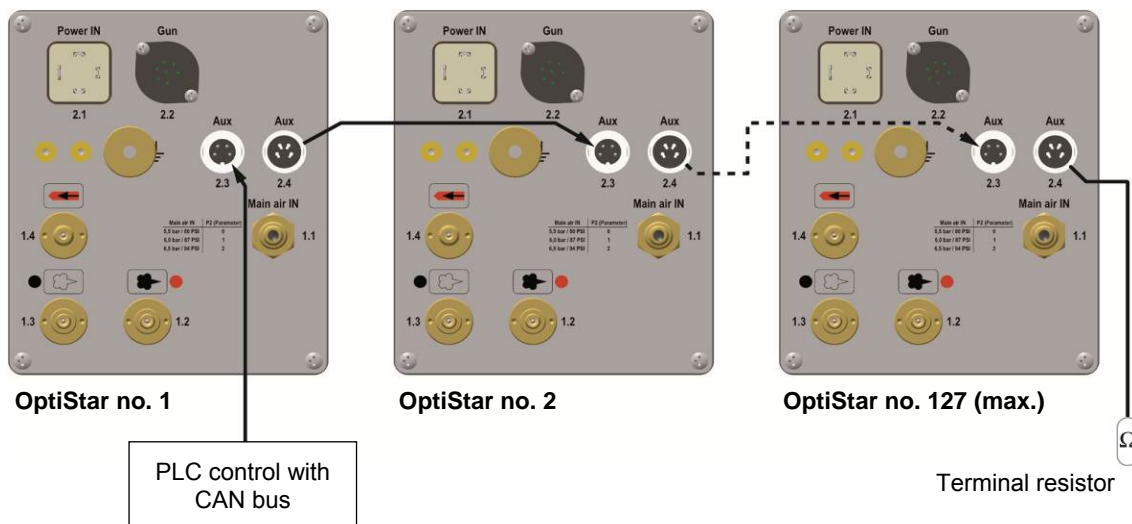

CAN bus - connections

CAN bus cable - plug assignment

Pin	Signal	Color
1	GND	white
2	+24 VDC	black
3	CAN H	black
4	CAN L	black

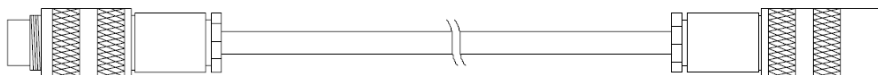

CAN bus cable

System release in network operation

The system release logic starts and stops the powder conveying and high voltage. The release is determined due to the several internal and external signals.

Signal	Designation
Ext. Release	System signal on mains plug
Trigger	Gun connected
Gun release	Local  or command via Remote Interface
Error Lock	Device error
System Lock	Parameter input

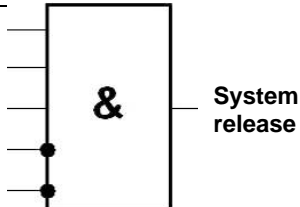

Determining user address (Node-ID) and Baud rate

Each OptiStar Gun control unit, which operates in the CAN network, must have assigned an individual user address (Node-ID). The Baud rate setting enables the transmission speed setting. The Baud rate value can be set by editing the system parameter P05, and the Node ID value can be set by editing the system parameter P06.

Baud rate - system parameter P05

P05 value	Baud rate
0	20 kBit/s
1	50 kBit/s
2	100 kBit/s
3	125 kBit/s
4	250 kBit/s
5	500 kBit/s
6	800 kBit/s
7	1 Mbit/s

Default value of system parameter P05 = 3

The Baud rate is selected with 125 kBits as default. This setting permits a maximum cable length of approx. 500 m from the first to the last CAN bus client. If longer cables are used, select a lower Baud rate.

Node ID - system parameter P06

CAN Node-ID 1-127

P06 value	CAN Node-ID
1-127	1-127

Fault remedying

Error diagnosis of the software

General information

The correct function of the OptiStar CG08(-C) Gun control unit is constantly monitored. If the equipment software determines a fault, an error message is indicated with a help code. Following is monitored:

- High voltage technology
- Pneumatic system
- Power supply

Help codes

The error diagnosis codes (help codes) are shown in red on the **A5** display.



The help codes are stored in an error list in the order of their appearance. Each error in the list must be individually acknowledged with the keys **T10** or **T11**.

The errors are displayed in the order of their appearance. The **T10** and **T11** keys cannot be used for other functions, as long as an error code is still shown.

Here is a list of all possible help codes for the OptiStar CG08(-C) Gun control unit:

Code	Description	Criteria	Remedy
Pneumatics:			
H06	Trigger valve	Solenoid coil current lower than preset limiting value Valve defective, main board or cable defective	contact Gema Service
H07	Supplementary air flow too high (Setting of supplementary air on the display)	The preset value for supplementary air is too high compared to the conveying air setting	Lower supplementary air value or increase value for conveying air to equalize air volumes to the injector, delete error code

Code	Description	Criteria	Remedy
H08	Conveying air volume too high (setting of powder share on the display)	The preset value for conveying air is too high compared to the supplementary air setting	Lower conveying air value or increase value for supplementary air to equalize air volumes to the injector, delete error code
H09	Powder output higher than 100%	The powder output multiplied by the powder hose length factor and daily correction value is greater than 100% Daily correction value too large	Reduce powder output Reduce daily correction value
H10	Conveying air range lower deviation	The theoretical value for conveying air falls below minimum Total air is smaller than minimum	Limit conveying air to its minimum value
High voltage:			
H11	Gun error	No vibrations in the oscillator, cable break, oscillator or gun is defective	contact Gema Service
H14	Offset spray current measurement	Grounded current measurement	contact Gema Service
Power supply:			
H20	Voltage supply error Mainboard	Mainboard defective	contact Gema Service
H21	Supply undervoltage	Power pack defective or overloaded	contact Gema Service
EEPROM (equipment memory):			
H24	EEPROM content invalid	EEPROM error	contact Gema Service
H25	Timeout during EEPROM writing	EEPROM error	contact Gema Service
H26	Values not correctly stored in EEPROM during switching off	EEPROM error	contact Gema Service
H27	EEPROM verification erroneous	EEPROM error	contact Gema Service
CAN bus:			
H40	Permanent CAN bus error	The CAN controller changes into BUS OFF condition No power supply or cable is not connected	Connect the cable, otherwise contact Gema service
H41	High error rate when transmitting/receiving	The CAN controller changes into ERROR_PASSIVE condition	contact Gema Service
H42	Overflow on data reception	The message to be received has no more place in the receiver buffer. Messages are sent faster than they can be processed	contact Gema Service
H43	Overflow on transmission	The message to be sent has no more place in the transmission buffer. Messages are produced faster than they can be sent	contact Gema Service
H44	Master failed	Node Guarding message is missing longer than 2 seconds. Connection to master failed	Check the connection to the Master, otherwise contact Gema service
H45	Parameter value outside the value range	The sent parameter value is outside the allowed value range	Check input values
H46	Invalid Node ID set	The Node ID is not between 1 and 127	Set Node ID to 127

Code	Description	Criteria	Remedy
H47	No CAN interface installed	CAN interface is selected in the system parameters, but no interface is installed	contact Gema Service
H48	No ACK to "Boot Up Message" received	No CAN node is answering to the "Boot Up Message".	Check cabling connections between the users, otherwise contact Gema service
Motor throttles:			
H60	Conveying air reference position not found	Throttle motor or needle jammed, limit switch defective, error in motor throttle	contact Gema Service
H61	Supplementary air reference position not found	Throttle motor or needle jammed, limit switch defective, error in motor throttle	contact Gema Service
H62	Electrode rinsing air reference position not found	Throttle motor or needle jammed, limit switch defective, error in motor throttle	contact Gema Service
H64	Conveying air throttle does not move	Short circuit in limit switch, motor throttle defective	contact Gema Service
H65	Supplementary air throttle does not move	Short circuit in limit switch, motor throttle defective	contact Gema Service
H66	Electrode rinsing air throttle does not move	Short circuit in limit switch, motor throttle defective	contact Gema Service
H68	Conveying air position lost	Lost steps, limit switch defective, throttle motor defective	contact Gema Service
H69	Supplementary air position lost	Lost steps, limit switch defective, throttle motor defective	contact Gema Service
H70	Electrode rinsing air position lost	Lost steps, limit switch defective, throttle motor defective	contact Gema Service
Communication Mainboard-Gun:			
H90	Communication error Mainboard	Mainboard defective	contact Gema Service
H91	Communication error Mainboard-Gun	Gun, gun cable or Mainboard defective	Replace or contact Gema Service
H92	Communication error Mainboard	Mainboard defective	contact Gema Service

Help codes list

The last appeared four errors are stored in a list by the software. If an error appears, which is already in the list, he will not be listed again.

Appearance of errors

It is possible that an error is only displayed for a short time, but after the acknowledgement it will disappear. In this case, it's recommended to switch off the control unit and switch it on again (reset by restarting).

Spare parts list

Ordering spare parts

When ordering spare parts for powder coating equipment, please indicate the following specifications:

- Type and serial number of your powder coating equipment
- Order number, quantity and description of each spare part

Example:

- **Type** OptiStar CG08(-C)
Serial number 1234 5678
- Order no. 203 386, 1 piece, Clamp - Ø 18/15 mm

When ordering cable or hose material, the required length must also be given. The spare part numbers of this bulk stock is always marked with an *.

Wearing parts are always marked with a #.

All dimensions of plastic hoses are specified with the external and internal diameter:

Example:

Ø 8/6 mm, 8 mm outside diameter (o/d) / 6 mm inside diameter (i/d)



WARNING!

Only original Gema spare parts should be used, because the explosion protection will also be preserved that way. The use of spare parts from other manufacturers will invalidate the Gema guarantee conditions!

OptiStar CG08(-C) Gun control unit

1	OptiStar CG08 Gun control unit – complete	1009 299
	OptiStar CG08-C Gun control unit – complete	1009 300
2	Cover	1008 301



OptiStar CG08(-C) Gun control unit

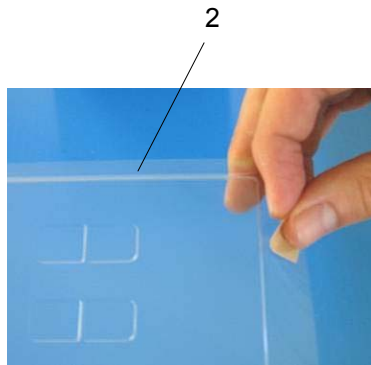

OptiStar CG08(-C) – Front plate and power pack

	Front plate - complete (pos. 1-12)	1009 860
	Front plate with foil keyboard (pos. 5-8)	1009 859
1	OptiStar Mainboard V2.0 - complete	1009 844
2	Spacer sleeve - Ø 3.1/6x15 mm	
3	PCB Powerboard V2.0	1009 865
4	Spacer sleeve - Ø 3.2/6x7 mm	
5	Front frame - complete (incl. pos. 5.1)	1007 048
5.1	Special screw	1007 019
6	Special screw – M4x20/7 mm	1003 000
7	Front plate gasket	1007 042
9	Spacer sleeve - Ø 3.6/7x5 mm	
10	Display	1007 044
11	Washer - Ø 3.2/7x0.5 mm	
12	Locknut - M3	
13	Power pack - 24 VDC	1009 849

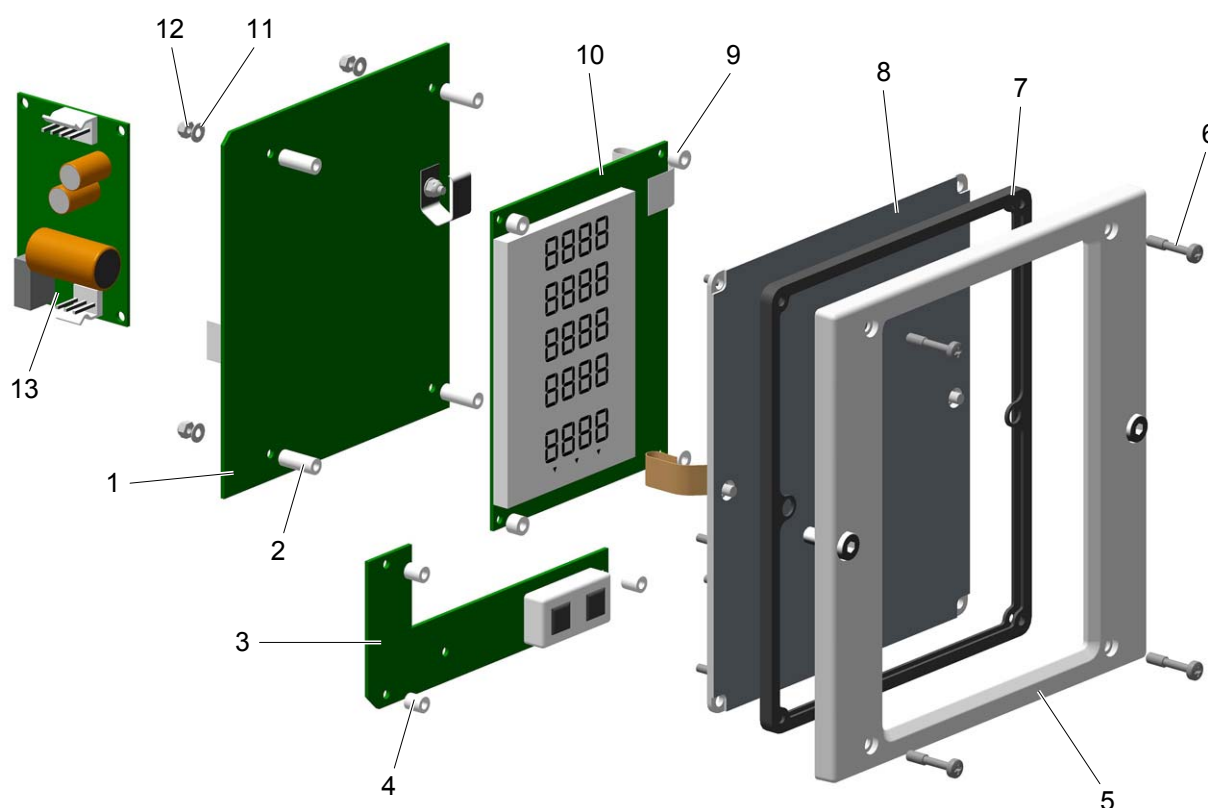

OptiStar CG08(-C) – Front plate and power pack

OptiStar CG08(-C) – inside rear wall

1	Rear panel gasket	1007 033
2	CAN-Bus Modul – komplett (nur CG08-C)	1009 068
3	Elbow plug-in connection - Ø 8-Ø 8 mm	230 995
4	Solenoid valve - Ø 8-Ø 8 mm, NW 3.4, 24 VDC	1003 914
5	Motor throttle - complete	1000 064
6	Plastic tube - Ø 8/6 mm	103 152*
7	Fluidizing pad - 1/8"a	237 264
8	Cap screw - M4x16 mm	216 801

* Please indicate length

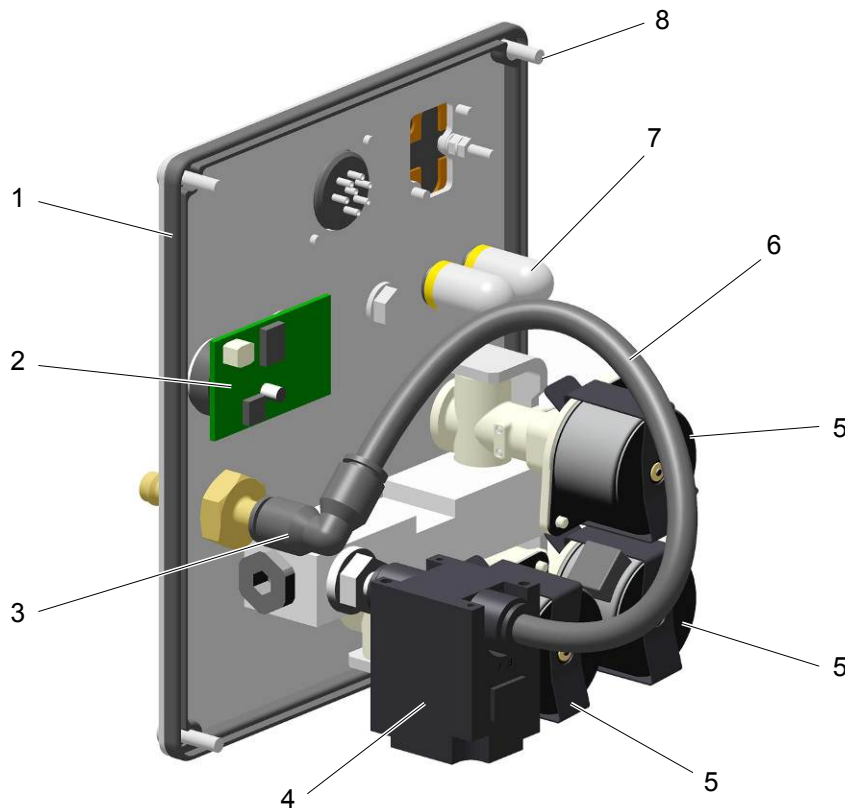

OptiStar CG08-C – inside rear wall

OptiStar CG08(-C) connections

1	Quick release connection – NW5, Ø 6 mm	200 840
1.1	Hose - Ø 6/4 mm	103 144*
2	Nut with kink protection – M12x1 mm, Ø 8 mm	201 316
2.1	Supplementary air hose - Ø 8/6 mm (black)	103 756*
2.2	Quick release coupling for supplementary air hose - NW5-Ø 8 mm	261 637
3	Nut with kink protection – M12x1 mm, Ø 8 mm	201 316
3.1	Conveying air hose - Ø 8/6 mm (red)	103 500*
3.2	Quick release coupling for conveying air hose - NW5-Ø 8 mm	261 645
4	Quick release connection – NW 5 mm	1004 272
4.1	Hose - Ø 8/6 mm	103 756*
5	CAN bus cable – 0.5 m (CG08-C only)	1002 655
	CAN bus cable – 4.5 m (CG08-C only)	387 592
	CAN bus cable – 5.5 m (CG08-C only)	388 521
	CAN bus cable – 6.0 m (CG08-C only)	388 530
6	Bus terminal resistor (not shown) (CG08-C only)	387 606
7	Mains cable – 4.5 m	1002 563

* Please indicate length

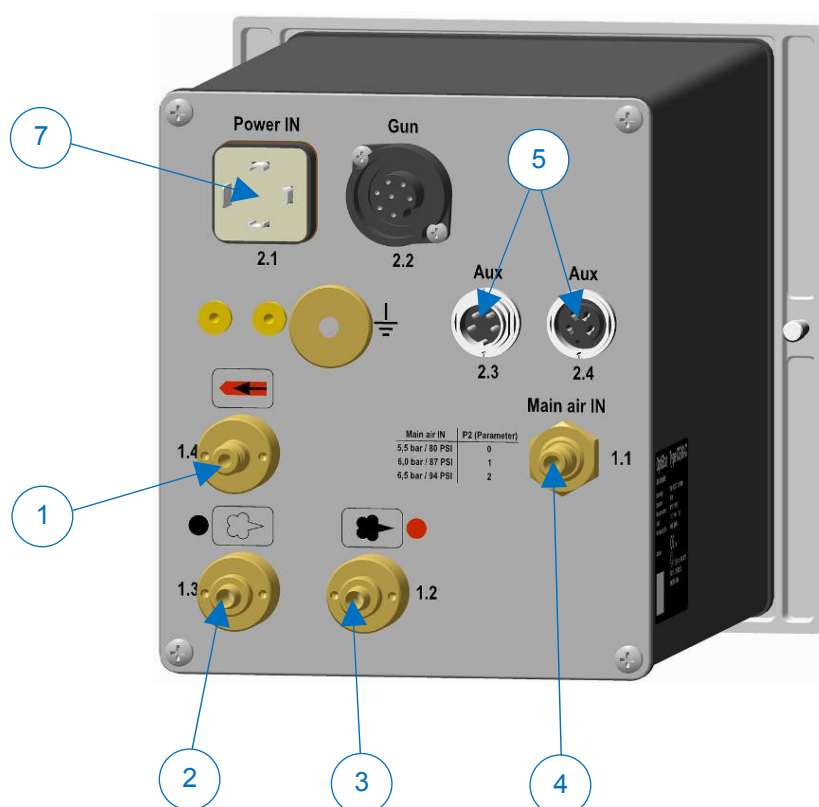

OptiStar CG08-C connections