

---

Operating instructions and Spare parts list

# Manual gun OptiSelect Pro GM04



Translation of the original operating instructions

**Documentation OptiSelect Pro GM04**

© Copyright 2018 Gema Switzerland GmbH

All rights reserved.

This publication is protected by copyright. Unauthorized copying is prohibited by law. No part of this publication may be reproduced, photocopied, translated, stored on a retrieval system or transmitted in any form or by any means for any purpose, neither as a whole nor partially, without the express written consent of Gema Switzerland GmbH.

Gema, EquiFlow, MagicCompact, MagicCylinder, OptiCenter, OptiFlex, OptiGun, OptiSelect and OptiStar are registered trademarks of Gema Switzerland GmbH.

ClassicLine, ClassicStandard, ClassicOpen, DVC (Digital Valve Control), GemaConnect, MagicControl, MagicPlus, MonoCyclone, MRS, MultiColor, MultiStar, OptiAir, OptiControl, OptiColor, OptiFeed, OptiFlow, OptiHopper, OptiMove, OptiSieve, OptiSpeeder, OptiSpray, PCC (Precise Charge Control), RobotGun, SIT (Smart Inline Technology) and SuperCorona are trademarks of Gema Switzerland GmbH.

All other product names are trademarks or registered trademarks of their respective holders.

Reference is made in this manual to different trademarks or registered trademarks. Such references do not mean that the manufacturers concerned approve of or are bound in any form by this manual. We have endeavored to retain the preferred spelling of the trademarks, and registered trademarks of the copyright holders.

To the best of our knowledge and belief, the information contained in this publication was correct and valid on the date of publication. Gema Switzerland GmbH makes no representations or warranties with respect to the contents or use of this publication, and reserves the right to revise this publication and make changes to its content without prior notice.

For the latest information about Gema products, visit [www.gemapowdercoating.com](http://www.gemapowdercoating.com).

For patent information, see [www.gemapowdercoating.com/patents](http://www.gemapowdercoating.com/patents) or [www.gemapowdercoating.us/patents](http://www.gemapowdercoating.us/patents).

**Printed in Switzerland**

Gema Switzerland GmbH  
Mövenstrasse 17  
9015 St.Gallen  
Switzerland

Phone: +41-71-313 83 00

Fax.: +41-71-313 83 83

E-mail: [info@gema.eu.com](mailto:info@gema.eu.com)

# Table of contents

<b>About these instructions</b>	<b>5</b>
General information .....	5
Keeping the Manual .....	5
Safety symbols (pictograms).....	5
Structure of Safety Notes.....	6
Presentation of the contents .....	6
Figure references in the text .....	6
<b>Safety</b>	<b>7</b>
General information .....	7
Basic safety instructions .....	7
Product specific security regulations .....	8
<b>Product description</b>	<b>9</b>
Intended use .....	9
Reasonably foreseeable misuse.....	10
Technical Data .....	10
Electrical data .....	10
Dimensions .....	10
Processible powders.....	10
Structure.....	11
Overall view.....	11
Operating elements.....	12
Scope of delivery .....	12
Available accessories** .....	13
PowerClean™ module – Option .....	13
SuperCorona ring.....	14
Principle of operation .....	15
High voltage generation .....	15
Circuit.....	15
Powder flow and electrode rinsing air.....	15
Flat jet nozzle with vented central electrode.....	16
Round jet nozzle with vented deflector and vented central electrode .....	16
Typical characteristics – properties of the functions .....	17
Remote control.....	17
Powder hose quick release connection .....	17
Connection for SuperCorona Ring.....	17
<b>Assembly / Connection</b>	<b>19</b>
Connecting the gun.....	19
<b>Start-up</b>	<b>21</b>
Preparation for start-up .....	21
Basic conditions .....	21
Initial start-up.....	22

<b>Operation</b>	<b>23</b>
Operation .....	23
Setting powder output and powder cloud .....	23
Setting the electrode rinsing air .....	24
Rinsing mode .....	25
Activating the rinsing function .....	25
<b>Decommissioning / Storage</b>	<b>29</b>
Decommissioning .....	29
If in disuse for several days .....	29
Storage conditions .....	29
Hazard notes .....	29
Type of storage .....	29
Storage duration .....	29
Space requirements .....	29
Physical requirements .....	30
Maintenance during storage .....	30
Maintenance schedule .....	30
Maintenance works .....	30
<b>Maintenance / Repairs</b>	<b>31</b>
Interval .....	31
Gun maintenance .....	31
Cleaning .....	31
Gun cleaning .....	32
Cleaning the spray nozzle .....	32
Replacing parts .....	33
Dismantling the gun .....	33
<b>Fault clearance</b>	<b>37</b>
<b>Disposal</b>	<b>39</b>
Introduction .....	39
Requirements on personnel carrying out the work .....	39
Disposal regulations .....	39
Materials .....	39
<b>Spare parts list</b>	<b>41</b>
Ordering spare parts .....	41
OptiSelect Pro GM04 – spare parts list .....	42
PowerClean™ module (Option) .....	44
SuperCorona .....	45
Accessories .....	46
Flat jet nozzles – overview (wearing parts) .....	46
Round jet nozzles – overview (wearing parts) .....	47
Gun extensions .....	48
Spray nozzles for extensions – overview (wearing parts) .....	49
Powder hoses – overview .....	50
Other accessories .....	50

# About these instructions

---

## General information

This operating manual contains all important information which you require for the working with the OptiSelect Pro GM04. It will safely guide you through the start-up process and give you references and tips for the optimal use when working with your powder coating system.

Information about the functional mode of the individual system components should be referenced in the respective enclosed documents.

---

## Keeping the Manual

Please keep this Manual ready for later use or if there should be any queries.

---

## Safety symbols (pictograms)

The following warnings with their meanings can be found in the Gema instructions. The general safety precautions must also be followed as well as the regulations in the relevant instructions.

### DANGER

Indicates a hazardous situation which, if not avoided, will result in death or serious injury.

### WARNING

Indicates a hazardous situation which, if not avoided, could result in death or serious injury.

### CAUTION

Indicates a hazardous situation which, if not avoided, could result in minor or moderate injury.

### ATTENTION

Indicates a potentially harmful situation. If not avoided, the equipment or something in its surrounding may be damaged.

**ENVIRONMENT**

Indicates a potentially harmful situation which, if not avoided, may have harmful consequences for the environment.

**MANDATORY NOTE**

Information which must be observed.

**NOTICE**

Useful information, tips, etc.

**Structure of Safety Notes**

Every note consists of 4 elements:

- Signal word
- Nature and source of the danger
- Possible consequences of the danger
- Prevention of the danger

**⚠ SIGNAL WORD**

**Nature and source of the hazard!**

**Possible consequences of the danger**

- ▶ Prevention of the danger

---

**Presentation of the contents****Figure references in the text**

Figure references are used as cross references in the descriptive text.

**Example:**

"The high voltage (**H**) created in the gun cascade is guided through the center electrode."

# Safety

---

## General information

This chapter provides the user and third parties who operate this product with all essential safety regulations, the adherence to which is imperative.

These safety regulations must be read and understood in their entirety before the product is put into operation.

The standards and guidelines applied during the development, manufacture and configuration are described in the EC declaration of conformity and in the manufacturer's declaration.

### **WARNING**

#### **Working without instructions**

**Working without instructions or with individual pages from the instructions may result in damage to property and personal injury if relevant safety information is not observed.**

- ▶ Before working with the device, organize the required documents and read the section "Safety regulations".
  - ▶ Work should only be carried out in accordance with the instructions of the relevant documents.
  - ▶ Always work with the complete original document.
- 

---

## Basic safety instructions

- This product is built to the latest specification and conforms to the recognized technical safety regulations and is designed for the normal application of powder coating.
- Any other use is considered non-compliant. The manufacturer shall not be liable for damage resulting from such use; the user bears sole responsibility for such actions. If this product is to be used for other purposes or other substances outside of our guidelines then Gema Switzerland GmbH should be consulted.
- Start-up (i.e. the execution of intended operational tasks) is forbidden until it has been established that this product has been set up and wired according to the guidelines for machinery. The standard "Machine safety" must also be observed.
- Unauthorized modifications to the product exempt the manufacturer from any liability from resulting damage.

- The relevant accident prevention regulations, as well as other generally recognized safety regulations, occupational health and structural regulations are to be observed.
- Furthermore, the country-specific safety regulations also must be observed.

---

## Product specific security regulations

- This product is a constituent part of the equipment and is therefore integrated in the system's safety concept.
- If it is to be used in a manner outside the scope of the safety concept, then corresponding measures must be taken.
- The installation work to be done by the customer must be carried out according to local regulations.
- It must be ensured, that all components are earthed according to the local regulations before start-up.



---

**For further security information, see the more detailed Gema safety regulations!**

---



# Product description

---

## Intended use

This gun is used for electrostatic coating of objects connectable to ground with organic powders in conjunction with the control units and accessories, as specified in the corresponding Type Examination Certificate.



*fig. 1*

Observance of the operating, service and maintenance instructions specified by the manufacturer is also part of conformity of use. This product should only be used, maintained and started up by trained personnel, who are informed about and are familiar with the possible hazards involved.



Any other use is considered non-compliant. The manufacturer is not responsible for any incorrect use and the risks associated with such actions are assumed by the user alone!

### Reasonably foreseeable misuse

- Use with insufficient compressed air quality
- Input pressure too low

## Technical Data

### Electrical data

OptiSelect Pro GM04	
Nominal input voltage	eff. 10 V
Frequency	18 kHz (average)
Nominal output voltage	110 kV
Polarity	negative <sup>LL</sup> (optional positive)
Max. output current	110 µA
High voltage display	with LED
Ignition protection	Ex 2 mJ T6
Temperature range	5 °C - +40 °C (+41 °F - +104 °F)
Max. surface temperature	85 °C (+185 °F)
Protection type	IP64
Approvals	 0102  II 2 D PTB 19 ATEX 5001

### Dimensions

OptiSelect Pro GM04	
Weight	550 g

### Processible powders

OptiSelect Pro GM04	
Plastic powder	yes
Metallic powder	yes
Enamel powder	no

## Structure

### Overall view

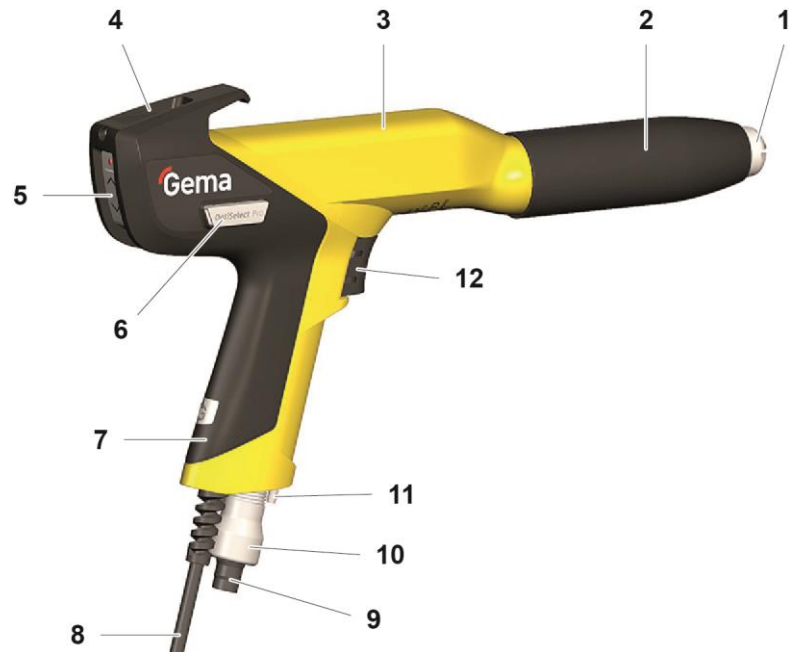

fig. 2:

- |   |                        |    |   |
|---|------------------------|----|---|
| 1 | Spray nozzle system    | 8  | Gun cable                                       |
| 2 | Threaded sleeve        | 9  | Powder hose connection                          |
| 3 | Shaft                  | 10 | Powder hose quick release connection (grounded) |
| 4 | Rear part with hook    | 11 | Electrode rinsing air connection                |
| 5 | Remote control         | 12 | Trigger   |
| 6 | SuperCorona connection |    |   |
| 7 | Gun handle             |    |   |

## Operating elements

### LED and remote control buttons



fig. 3

Designation	Function
L1	Display <b>High voltage (intensity)</b>
T1	Key <b>Increase value</b>
T2	Key <b>Decrease value</b>
T3	Key <b>P</b> – Function according to system parameter in the OptiStar control unit

## Scope of delivery

- manual gun with gun cable (6 m), negative polarity
- Powder hose (6 m)
- Rinsing air hose (6 m)
- Flat jet nozzle NF40, complete (incl. electrode holder)
- Flat jet nozzle NF20, complete (incl. electrode holder)
- Cable tie with Velcro closure
- Gun cleaning brush
- Spare parts kit
- Operating manual

---

## Available accessories\*\*

- SuperCorona ring
- Flat jet nozzles
- Round jet nozzles
- Gun extension 150 and 300 mm
- Gun cable extensions
- Application cup 150 and 500 ml
- Multi-spray adapter
- Rinsing module (with corresponding OptiStar control unit only)
- Various adapters for connection to earlier generations of control units
- Gloves, anti-static

\*\*for more information, see spare parts list

## PowerClean™ module – Option

### *Field of application*

The PowerClean module can be used in combination with the OptiStar control unit.

The PowerClean module provides increased stability in application processes. It prevents the bridging phenomena that can lead to short circuiting when handling powders such as metallic powders.

In moist or tropical environments, any moisture is driven from the injector, powder hose and powder gun. The color change is also accelerated during non-extreme color switches.



fig. 4

## SuperCorona ring

### *Field of application*

The SuperCorona is an optional extension for the gun, allowing for a better surface quality when coating with the powder coating equipment.

When coating wheel rims, drawers, radiators, lamps etc. the surface quality is exceptional, also in places with higher coating layer requirements. By coating with several powder types, an "orange peel" finish can be completely avoided. By coating with structure powder, the "picture frame effect" is hardly visible.

The performance of the gun with SuperCorona is convincing due to its very good charging and very high deposition rate as well as an improved penetration into Faraday cages. The distance between nozzle and workpiece can be reduced to 100 mm without influencing the surface finish.

Due to its modular structure, the gun can be fast and easily extended with the light SuperCorona (approx. 60 g). The gun remains repair-friendly and easy to maintain even after reconfiguration.

### *SuperCorona assembly*

Before fitting the SuperCorona ring, make sure that the connection and the plug-in connector are free from grease and powder; otherwise the electric contact cannot be guaranteed.



## Principle of operation

### High voltage generation

The control unit supplies a high-frequency low voltage signal of approx. 10 V eff. This voltage is fed through the gun cable (1) to the high voltage cascade (2) in the gun shaft.

In the high voltage cascade (2), the low voltage is high-transformed in a first step (c). This primary high voltage is subsequently rectified and multiplied in the high voltage cascade in a second step (d), until the required high voltage is obtained at the end (approx. 110 kV). The high voltage is now fed to the electrode (e) within the spray nozzle.

### Circuit

In addition to the modulated low voltage needed for high voltage generation, there are signal lines fed through the gun cable. The control signals are used for monitoring gun trigger status and gun remote control functions.

The gun is released by a touch-free switch (3), which is operated by a magnet (4) in the trigger (5). The gun control unit switches on the modulated low voltage, the powder transport and the rinsing air.

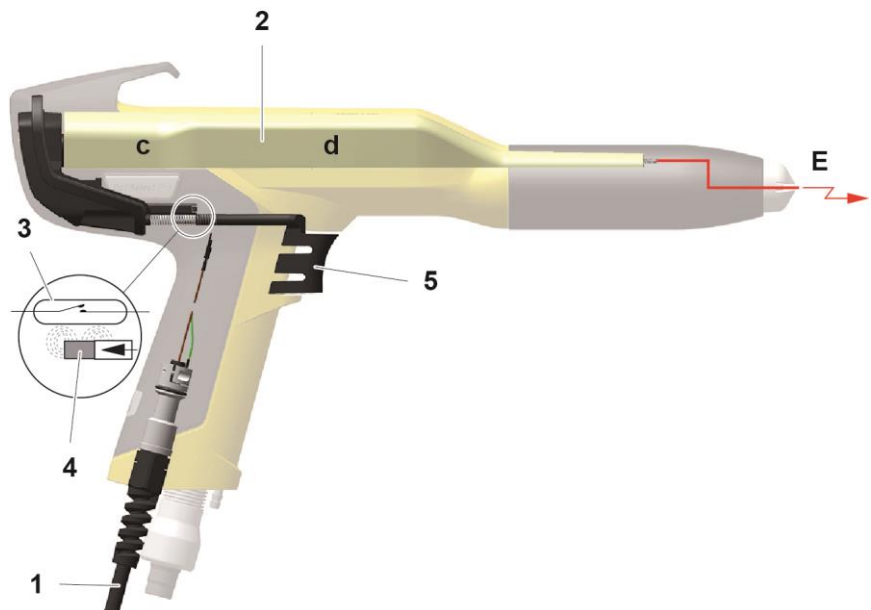

fig. 5

### Powder flow and electrode rinsing air

The electrode rinsing air is used by vented spray nozzles and is connected with its designated connection on the rear side of the gun control unit (see the operating manual of the gun control unit). The functions of the spray nozzles are described in the corresponding section of this manual.

## Flat jet nozzle with vented central electrode

The vented flat jet nozzle serves for the spraying and the charging of the powder. The powder is charged by the central electrode (**E**). The high voltage (**H**) created in the gun cascade is guided through the center electrode.

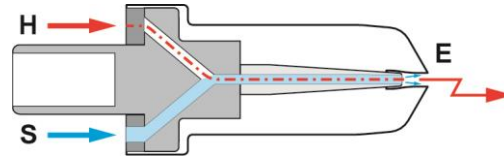

*fig. 6*

In order to prevent powder from sintering on the electrode, compressed air is used during the spray process.

The electrode rinsing air (**S**) adjustment on the gun control unit is described in the corresponding operating manual.

## Round jet nozzle with vented deflector and vented central electrode

The vented deflector is used, to give the powder stream emerging from the gun, a cloud formation. The powder is charged by the central electrode (**E**). The high voltage (**H**) created in the gun cascade is guided through the center electrode.

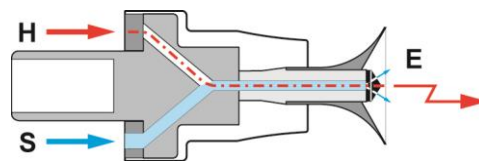

*Fig. 7*

Since powder can accumulate on the baffle plate, it must be rinsed with compressed air.

The electrode rinsing air (**S**) adjustment on the gun control unit is described in the corresponding operating manual.



## Typical characteristics – properties of the functions

### Remote control

Three possibilities are available:

- 1 Change the powder output + Activate/stop rinsing process (factory setting)
- 2 Program change + Activate/stop rinsing process
- 3 Change the powder output + Activate/stop the PowerBoost function



**The respective option is set in the OptiStar control unit in accordance with system parameter P12.**

- See therefore the corresponding operating manual.



- Adapt powder output (The powder output is correspondingly increased or reduced)
- Program change (It is switching between programs P01-P20)



- Activating/Deactivating the rinse mode: the entire powder line from the suction area to the gun is rinsed
- direct temporary activation of the PowerBoost function. Press again to return to the previous setting. (See therefore the corresponding OptiStar CG21/CG23-P operating manual)

### Powder hose quick release connection



- Quick and simple connection and disconnection from powder hose and application cup
- Protective function through to grounded clip ring

### Connection for SuperCorona Ring



- Quick and simple connection to and disconnection from the SuperCorona ring



# Assembly / Connection

---

## Connecting the gun

The gun is delivered ready-to-use by the manufacturer. Just a few cables and hoses must be connected.



---

**The compressed air must be free of oil and water!**

---

The gun is connected as follows:

1. Connect electrode rinsing air hose and powder hose to gun
2. Lay out gun cable, electrode rinsing air hose and powder hose and bind using Velcro strips (included)
3. Connect the gun cable plug to the socket **2.3** on the rear side of the control unit
4. Connect electrode rinsing air hose to coupling **1.4**
5. Connect powder hose to injector

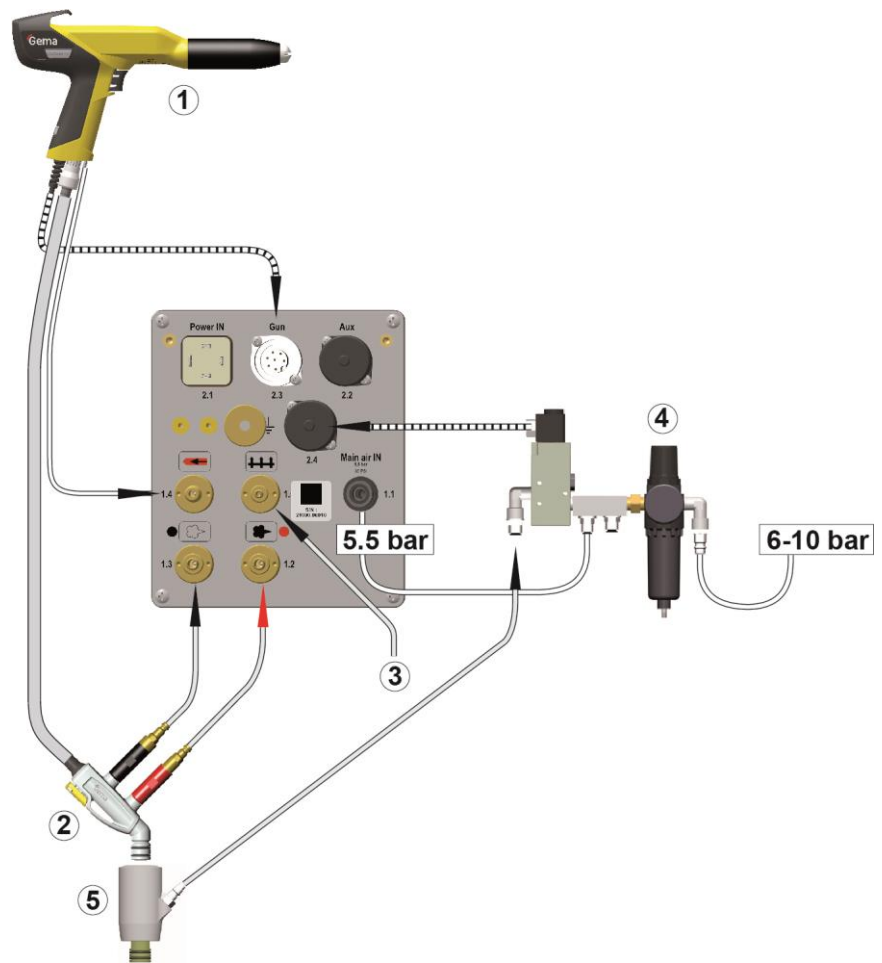

fig. 8

- |                       |                               |
|-----------------------|-------------------------------|
| 1 Gun                 | 4 Maintenance unit            |
| 2 Injector            | 5 PowerClean™ module (Option) |
| 3 Fluidizing air hose |                               |

# Start-up

---

## Preparation for start-up

### Basic conditions

When starting up the gun control unit, the following general conditions impacting the coating results must be taken into consideration:

- Gun correctly connected
- Gun control unit correctly connected
- Corresponding power and compressed air supply available
- Powder preparation and powder quality OK

## Initial start-up



If a malfunction occurs, see the troubleshooting guide, as well as the gun control unit operating manual!

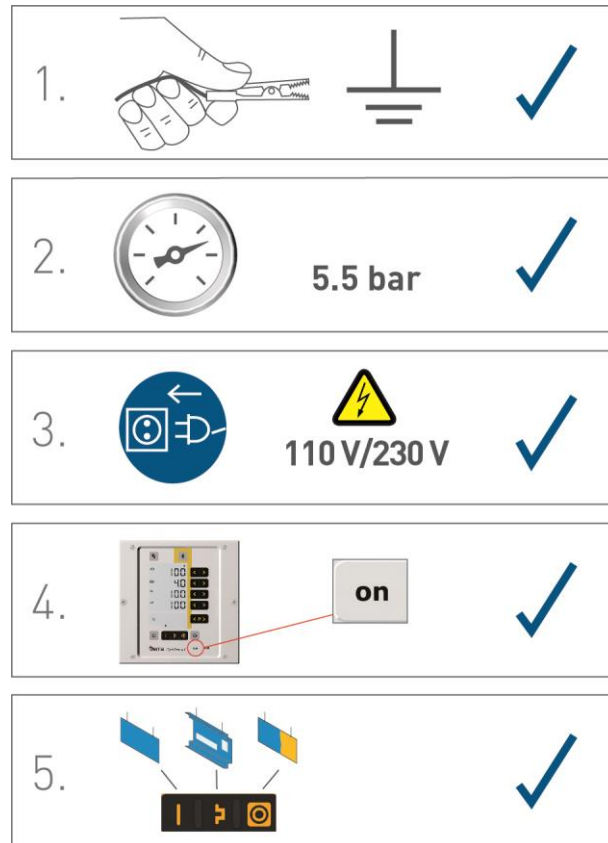

fig. 9



The remainder of the start-up procedure for the gun is explicitly described in the operating instructions for the OptiStar CGxx manual powder gun control unit (chapter "Initial start-up" and "Daily start-up")!

# Operation

## WARNING

### Holding the gun incorrectly

During the coating process, the gun can discharge along the body of the coater if not held using its intended handle, which has been grounded.

- ▶ Always hold gun only by the handle!
- ▶ Do not touch any other parts of the gun!

---

## Operation

### Setting powder output and powder cloud

The powder output depends on the selected powder output (in %), and the powder cloud on the selected total air volume.



**As a factory default value, a powder rate of 50% and a total air volume of 4 Nm<sup>3</sup>/h are recommended.**

- If values are entered that the gun control unit cannot implement, then the operator is informed of this by a blinking in the relevant display and a temporary error message!

### Setting the total air volume

1. 

Adjust the total air volume on the gun control unit with the **T3/T4** keys

- Adjust the total air volume according to the corresponding coating requests



*correct powder cloud*



*too little total air*

### Setting the powder output



*much powder*



*little powder*

Adjust the powder output volume (e.g. according to the desired coating thickness)

- Factory default setting of 50% is recommended for initial operation. The total air volume is thereby kept constant automatically by the control unit.



**To achieve maximum efficiency, we recommend avoided an overly high powder volume where possible!**

2. Check fluidization of the powder in the powder container
3. Point the gun into the booth, switch the gun on and visually check the powder output

### Setting the electrode rinsing air

1. Press the  key.  
The second display level will be shown.



Adjust the correct electrode rinsing air according to the applied nozzles (deflector plate, flat jet nozzle)



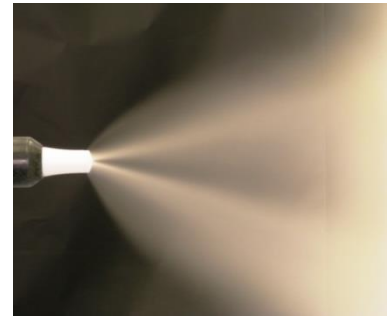
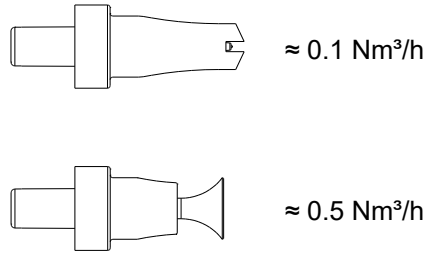

*too much electrode rinsing air*

3. If in this display level is no operation for 3 seconds, the first display level is switched over independently.

## Rinsing mode

The rinsing mode enables blowing off powder accumulations in the powder hose.

### Activating the rinsing function

#### **Manual equipment without optional PowerClean module (system parameter P01=0)**

The rinsing mode can only be activated from standby mode (main menu display, no powder conveying).



**On manual coating equipment type F, the injector must be disconnected prior to cleaning procedure, on type B, the suction unit must be lifted, and on type S, the powder container must be empty.**

1. Detach the injector



- 2.

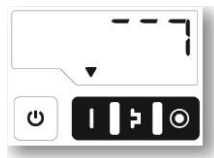

3. **START =**



**1 x**  
= Automatic Procedure

**2 x**  
= Manual Procedure

Procedure	Effect
<b>Automatic (automatic)</b>	<ul style="list-style-type: none"> <li>- The rinsing process is started</li> <li>- Injector, powder hose, gun and spray nozzle are purged using compressed air</li> <li>- The PowerClean function enables parallel cleaning of other components, such as the fluid intake unit, powder container, etc.</li> <li>- The rinsing mode is exited if the automatic rinsing sequence has finished.</li> </ul>
<b>Manual (manual)</b>	The operator controls the number and length of the PowerClean impulse by pressing the gun trigger a second time

4. **STOP =**



OR



OR the cleaning mode is terminated automatically.

After completion of the PowerClean procedure, the controller switches back to coating mode.

**Manual equipment with optional PowerClean module (system parameter P01= 1 or P01=2)**

The rinsing mode can only be activated from standby mode (main menu display, no powder conveying).



OR

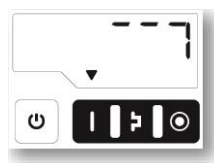

2. **START =**

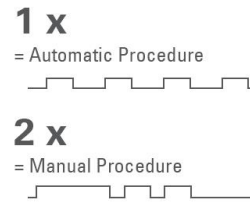

Procedure	Effect
<b>Automatic (automatic)</b>	<ul style="list-style-type: none"> <li>- The rinsing process is started</li> <li>- Injector, powder hose, gun and spray nozzle are purged using compressed air</li> <li>- The PowerClean function enables parallel cleaning of other components, such as the fluid intake unit, powder container, etc.</li> <li>- The rinsing mode is exited if the automatic rinsing sequence has finished.</li> </ul>
<b>Manual (manual)</b>	The operator controls the number and length of the PowerClean impulse by pressing the gun trigger a second time

3. **STOP =**



OR



OR the cleaning mode is terminated automatically.

After completion of the PowerClean procedure, the controller switches back to coating mode.



# Decommissioning / Storage

---

## Decommissioning

1. End the coating procedure
2. Switch off the control unit



---

**The adjustments for high voltage, powder output volume and electrode rinsing air remain stored.**

---

### If in disuse for several days

1. Separate from power mains
2. Clean guns, injectors and powder hoses (see therefore the corresponding user manuals)
3. Turn off the compressed air main supply

---

## Storage conditions

### Hazard notes

There is no danger to personnel or the environment if the unit is stored properly.

### Type of storage

For safety reasons, the product should only be stored in a horizontal position

### Storage duration

If the physical conditions are maintained, the unit can be stored indefinitely.

### Space requirements

The space requirements correspond to the size of the product.

There are no special requirements concerning distance to neighboring equipment.

## **Physical requirements**

Storage must be inside a dry building at a temperature between +5 and +50 °C. Do not expose to direct sunlight!

---

## **Maintenance during storage**

### **Maintenance schedule**

No maintenance schedule is necessary.

### **Maintenance works**

During long-term storage, periodically perform a visual check.

# Maintenance / Repairs

---

## Interval

### Gun maintenance

The gun is designed to require only a minimum amount of maintenance.

1. Clean the gun with dry cloth, see chapter "Maintenance"
2. Check connection points to powder house.
3. Replace the powder hoses, if necessary.

---

## Cleaning

### ATTENTION

**Any unauthorized modifications and alterations to the product are not permitted for safety reasons and exclude the manufacturer's liability for any resulting damage!**



---

**Regular and conscientious cleaning and maintenance increase the service life of the product and ensure consistent high coating quality!**

- The parts to be replaced during maintenance work are available as spare parts. These parts can be found in the appropriate spare parts list!
-

## Gun cleaning

### ATTENTION

#### Impermissible solvents

The following solvents may not be used to clean the gun:

- ▶ Ethylene chloride, acetone, ethyl acetate, methyl ethyl ketone, methylene chloride, premium gasoline, turpentine, tetrachloromethane, toluene, trichloroethylene, xylene!



Only cleaning agents with a flash point of a least 5 Kelvin above the ambient temperature, or cleaning places with technical ventilation are allowed!



Before cleaning the powder gun, switch off the control unit. The compressed air used for cleaning must be free of oil and water!

#### *Daily:*

1. Blow off the outside of the gun and wipe, clean etc.

#### *Weekly:*

2. Remove powder hose
3. Remove the spray nozzle from the gun and clean it with compressed air
4. Blow through the gun with compressed air, beginning from the connection in flow direction
5. Clean the integrated gun tube with the brush supplied if necessary
6. Blow through the gun with compressed air again
7. Clean the powder hose
8. Reassemble the gun and connect it

## Cleaning the spray nozzle

#### *Daily or after every shift*

1. Clean the inside and outside of the spray nozzle with compressed air.  
Never immerse the parts in solvents!
2. Check the seating of the spray nozzles.

### ATTENTION

#### Threaded sleeve not tightened well

If the spray nozzle is just fitted loosely, there is danger of a flash-over of the gun high voltage, which can damage the gun!

- ▶ Always tighten the threaded sleeve well!



### **Weekly:**

1. Remove the spray nozzle and clean on the inside with compressed air. If sinterings should have formed, then they have to be removed!

### **Monthly**

1. Check spray nozzle for wear

The flat jet nozzle is to be replaced, if:

- the spray pattern is no longer a regular oval
- deeper grooves are in the nozzle slot, or even the wall thickness is no longer recognizable
- the wedge of the electrode holder is worn

Nozzles with deflectors:

- if the wedge of the electrode holder is worn down, then the electrode holder is to be replaced

## **Replacing parts**

Except for the replacement of possible defective parts, there are very few repairs to be made.



---

**The replacement of the cascade and the repair of the powder gun cable connection is only permitted by an authorized Gema Service center!**

- Contact your Gema representative!
- 

## **Dismantling the gun**

### **General information**



---

**The gun should only be dismantled, if this is required because of a defect or pollution.**

- Dismantle the gun only so far, as the desired part is accessible!
- 

### **⚠ WARNING**

#### **Touching the gun parts**

**During work on the gun, the gun can discharge along the body of the coater if touching it.**

- ▶ Before dismantling the gun, switch off the control unit and disconnect the gun plug!
-

***Dismantling procedure***

1.



2.



3.



### ***Assembling the powder gun***

The assembling is to be carried out in the reverse order to that shown above.



1.



# Fault clearance



**Additional error descriptions are to be found also in the control unit operating instructions!**

Incident	Causes	Corrective action
<b>H11 (Help code on control unit)</b>	Gun not connected	Connect the gun
	Gun plug or gun cable defective	Contact local Gema representative
	Remote control on powder gun defective	Contact local Gema representative
<b>Gun LED remains dark, although the gun is triggered</b>	High voltage adjustment is set too low	Increase high voltage
	Gun plug or gun cable defective	Contact local Gema representative
	LED on gun defective	Contact local Gema representative
<b>Powder does not adhere to object, although the gun is triggered and sprays powder</b>	High voltage and current deactivated	Check the high voltage and current setting
	High voltage cascade defective	Contact local Gema representative
	The objects are not properly grounded	Check the grounding
<b>The gun does not spray powder, although the control unit is switched on and the gun trigger is pressed</b>	Compressed air not present	Connect the equipment to the compressed air
	Injector or nozzle on the injector, powder hose or powder gun clogged	Clean the corresponding part
	Insert sleeve in the injector is clogged	Clean/replace
	Pressure valve in the control unit defective	Replace
	Solenoid valve in the control unit defective	Replace
	No conveying air: <ul style="list-style-type: none"> <li>– Throttle motor defective</li> <li>– Solenoid valve defective</li> </ul>	Contact local Gema representative
	Front plate defective	Contact local Gema representative

Incident	Causes	Corrective action
<b>Gun achieving only poor spray profile</b>	Total air incorrectly configured	Increase the powder quantity and/or total air volume on the control unit
	Bend or damage to air lines to injector	Check air lines to injector
	Insert sleeve in the injector worn or not inserted	Replace or insert it
	Fluidization not running	see above

# Disposal

---

## Introduction

### Requirements on personnel carrying out the work

The disposal of the product is to be carried out by the owner or operator.

When disposing of components that are not manufactured by Gema, the instructions in the respective manufacturer's documentation must be observed.

### Disposal regulations



---

**The product must be disassembled and disposed of properly at the end of its service life.**

- ▶ When disposing of the product, the applicable local and regional laws, directives and environmental regulations must be complied with!
- 

### Materials

The materials must be sorted according to material groups and taken to the appropriate collection points.





# Spare parts list

---

## Ordering spare parts

When ordering spare parts for powder coating equipment, please indicate the following specifications:

- Type and serial number of your powder coating equipment
- Order number, quantity and description of each spare part

**Example:**

- **Type** OptiGun GA03 automatic powder gun  
Serial number 1234 5678
- **Order no.** 203 386, 1 piece, Clamp – Ø 18/15 mm

When ordering cable or hose material, the required length must also be given. The spare part numbers of this bulk stock is always marked with an \*.

Wearing parts are always marked with a #.

All dimensions of plastic hoses are specified with the external and internal diameter:

**Example:**

Ø 8/6 mm, 8 mm outside diameter (o/d) / 6 mm inside diameter (i/d)

### ATTENTION

**Use of non-original Gema spare parts**

**When using the spare parts from other manufacturers the explosion protection is no longer guaranteed. If any damage is caused by this use all guarantee claims become invalid!**

- ▶ Only original Gema spare parts should be used!
-

## OptiSelect Pro GM04 – spare parts list



**Only parts were included in the spare parts list, which the user can replace himself without problems!**

- ▶ If the powder gun cable is defective, it is to be completely sent in for repair!

<b>A</b>	OptiSelect Pro GM04 manual powder gun – complete incl. flat jet nozzle, brush and parts kit, without powder hose, with:	
	gun cable 6 m, rinsing air hose 6 m, negative polarity (-)	1016 971
	gun cable 12 m, rinsing air hose 12 m, negative polarity (-)	1016 972
	gun cable 6 m, rinsing air hose 6 m, positive polarity (+)	1016 973
	gun cable 12 m, rinsing air hose 12 m, positive polarity (+)	1016 974
<b>B</b>	Manual powder gun shaft OptiSelect Pro GM04 (incl. cascade) with:	
	Gun cable 6 m, negative polarity (-)	1018 700
	Gun cable 12 m, negative polarity (-)	1018 701
	Gun cable 6 m, positive polarity (+)	1018 702
	Gun cable 12 m, positive polarity (+)	1018 703
1	Gun body – complete	1017 680
2	Cascade – complete, negative polarity, incl. pos. 3	1016 911
	Cascade – complete, positive polarity, incl. pos. 3	1016 912
3	Buffer	1017 704
4	Print holder – complete	1017 690
5	Rear part	1017 683
6	Trigger – complete	1017 686
7	Trigger cover	1017 688
8	Countersunk-head screw – M4x6 mm	1017 698
9	SuperCorona connection	1017 684
10	Gun cable 6 m – complete	1016 952
	Gun cable 12 m – complete	1016 953
11	Rinsing air connection	1017 656
11.1	Rinsing air hose	100 854*
12	Powder tube – complete	1007 958 #
13	Compression spring	1001 488
14	Clip ring	1007 960
15	Hose connection Ø 11-12 mm – complete (incl. pos 15.1)	1001 340 #
	Hose connection Ø 9-10 mm – complete (incl. pos 15.1)	1002 030 #
15.1	O-ring for pos. 15	1000 822 #
16	Threaded sleeve (see corresponding spare parts list)	
17	Nozzle (see corresponding spare parts list)	
18	Cable lock	1017 685
19	Screw – M3x20 mm	1017 674
20	Contact strip	1018 707
21	Fitting bush	1018 708

Cleaning brush – Ø 12 mm (not shown)	389 765
<b>Parts set (not shown), consisting of:</b>	<b>1008 302</b>
Multi-spray adapter	1003 634#
Cable clamp	303 070
Hose connector – complete, for hose interior Ø 9-10 mm	1002 030
Powder hose – Ø 10 mm (not shown)	1001 673*#
Powder hose – Ø 11 mm (not shown)	105 139*#

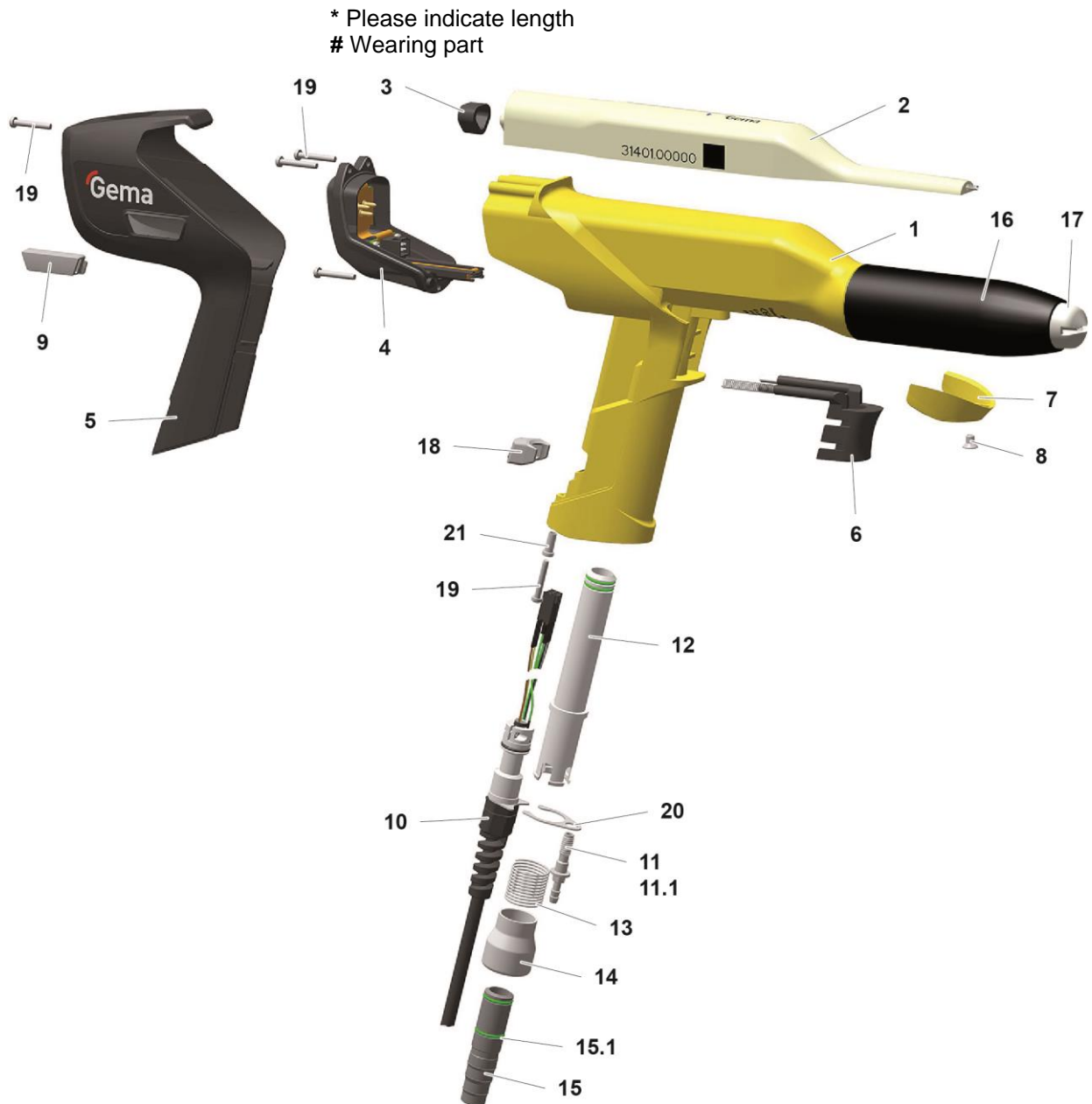

fig. 10: OptiSelect Pro GM04 – spare parts

## PowerClean™ module (Option)

	PowerClean module – complete	1009 528
1	Elastomer valve	1000 089#
2	O ring – Ø 16x2 mm, anti-static	1007 794#
3	Fluidizing tube bearing	1007 356
4	Fluidizing tube	1007 355
5	Retaining bracket	1009 524
6	O-ring – Ø 27x2 mm	1009 525

# Wearing part

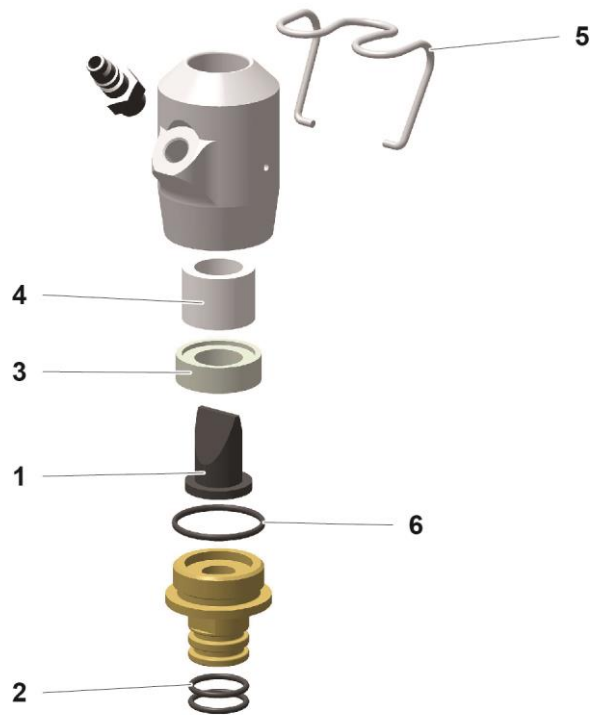

fig. 11

---

# SuperCorona

---

1	SuperCorona PC..	1018 291#
---	------------------	-----------

---

# Wearing part

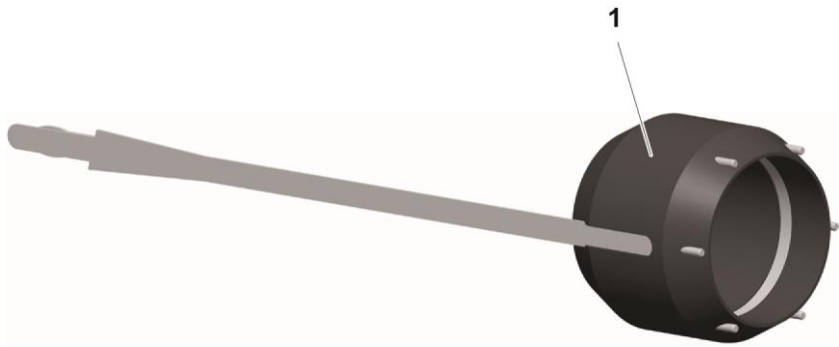









fig. 12



## Accessories

### Flat jet nozzles – overview (wearing parts)







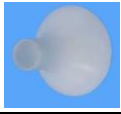

Application	A	B	A + B	Threaded sleeve
Profiles/flat parts	 NF20 1010 090		<b>NF20</b> 1010160	 1007 229
Profiles/flat parts	 NF27 1010 752		<b>NF27</b> 1010 754	
Complex profiles and depressions	 NF21 1007 935	 1007 683	<b>NF21</b> 1007 932	
Complex parts (deep recess); target spraying	 NF22 1008 145		<b>NF22</b> 1008 140	
Profiles/big flat parts (standard nozzle)	 NF40* 1018 165		<b>NF40</b> 1018 166	
Large surfaces	 NF24* 1008 147		<b>NF24</b> 1008 142	

\* not suitable for angled nozzles

### Round jet nozzles – overview (wearing parts)

Application	A	B	A + B	Threaded sleeve	Deflectors
Suitable for large surfaces	 NS04 1008 151	 1008 152	<b>NS04</b> 1008 150	 1007 229	
					Ø 16 mm 331 341
					Ø 24 mm 331 333
					Ø 32 mm 331 325

## Gun extensions

Gun extensions		
	L = 150 mm	L = 300 mm
without nozzle <sup>1</sup>	 1008 616	 1008 617
without nozzle <sup>2</sup>	 1007 718	 1007 719
with Flat jet nozzle NF25	 1007 746	 1007 747
with Round jet nozzle NS09	 1007 748	 1007 749

<sup>1</sup> see NF27, NF20, NF21, NF24, NS04

<sup>2</sup> see NF25, NF26, NS09

### ATTENTION

#### Connecting more than two extensions

**It is not permitted to connect more than two extensions together, in order to prevent the gun from being damaged by arising leverage force.**

- ▶ The extensions (150 mm/300 mm) may be connected TO ONLY ONE ADDITIONAL extension (150 mm/300 mm), if necessary.



### Spray nozzles for extensions – overview (wearing parts)



1007 718



1007 719

Application	A	B	A + B	Threaded sleeve	Deflectors
Profiles/flat parts	 NF25 1007 735	 1007 684	<b>NF25</b> 1007 743	 1007 740	--
Complex profiles and depressions	 NF26 1007 742	 1007 684	<b>NF26</b> 1007 744		--
Suitable for large surfaces	 NS09 1008 257	 1008 258	<b>NS09</b> 1008 259		 Ø 16 mm 331 341 Ø 24 mm 331 333 Ø 32 mm 331 325

## Powder hoses – overview

Powder hose (antistatic)	Application	Diameter	Parts No.*	Material	Type
 <p>                     Ø 12/ 18 mm Typ 75 Material POE                 </p> <p>                     Ø 11/ 16 mm Typ 66 Material POE                 </p> <p>                     Ø 10/ 15 mm Typ 74 Material POE                 </p>	Fast color changes	Ø 11/16 mm	105 139	POE	66
	Fast color changes - low powder flow	Ø 10/15 mm	1001 673	POE	74
	Fast color changes - high powder flow	Ø 12/18 mm	1001 674	POE	75

\* Please indicate length

## Other accessories

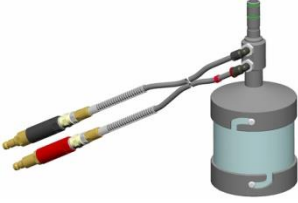
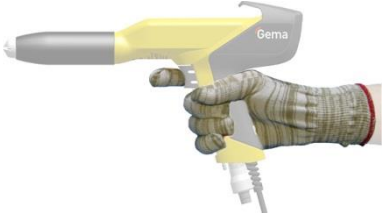
Application cup	150 ml  1004 552	500 ml  1002 069
	Gloves, anti-static (1 pair)  800 254	

# Index

## A

About these instructions.....	5
Assembly.....	19

## B

Basic safety instructions.....	7
--------------------------------	---

## C

Cleaning.....	31
Connection.....	19

## D

Decommissioning.....	29
Disposal.....	39
Disposal regulations.....	39
Disuse for several days.....	29

## E

Electrical data.....	10
----------------------	----

## F

Fault clearance.....	37
Figure references in the text.....	6

## I

Intended use.....	9
-------------------	---

## M

Maintenance.....	31
Maintenance during storage.....	30

## N

Nozzles	
Flat jet nozzle.....	16

## O

Operation.....	23
----------------	----

## P

Pictograms.....	5
PowerBoost function	
activation.....	17
PowerClean™ module.....	13
Presentation of the contents.....	6
Product description.....	9
Product specific security regulations.....	8

## R

Remote control.....	17
Repairs.....	31

## S

Safety.....	7
Safety symbols.....	5
Spare parts list.....	41
Start-up.....	21
Storage.....	29
Storage conditions.....	29

## T

Technical Data.....	10
---------------------	----

